

Combi

AuraStar

**This product is a stroller with Intelligent Auto-Brake device.
Operation of the Intelligent Auto-Brake function is conditional.
Please read this manual for details.**

- Before use, please read this instruction carefully and use it correctly.
- Please keep this manual for future reference.
- Follow the instructions in this manual when assembling the required parts.
- Please also attach this manual if you transfer this product to others.

**本產品是附帶自動剎車輔助裝置的嬰兒手推車。
自動剎車運作是有條件的。
詳情請閱讀本書。**

- 使用前，請仔細閱讀本說明書，並正確使用。
- 請妥善保管本說明書，以供日後參考之用。
- 需要安裝部件時，請詳閱本說明書後正確安裝。
- 若將本產品轉讓他人，請將本說明書一併移交對方。



EN Instruction manual

繁體中文 說明書



WARNING (Incorrect operation may cause serious injury or death)

Please read this instruction manual carefully and keep it for future reference. The safety of the child may be seriously endangered if the instructions are not followed. You are personally responsible for the safety of your child.

- The stroller is suitable for children from newborn 1 month to 15kg.(approximately 3 years old) under EN 1888-1:2018 safety standard and CNS 12940.
- Always apply the parking brake when you are stationary.
- Do not rely too much on the stopper even when the stroller is parked empty.
- Even with all stopper engaged, always stay close to the stroller when it is carrying a child, in case of any danger.
- Keep all small parts away from children as they are choking hazard.
- To prevent the risk of suffocation, always keep the plastic bags out of the reach of children.
- Overloading, incorrect folding and the use of non-approved accessories may damage this stroller.
- Make sure to use the seat belt (crotch belt, waist belt and shoulder belt) when the child is seated. The front guard is not designed to prevent the child from standing up. Check if the seat belt fits properly, otherwise the baby may fall off from the stroller.
- Pay attention to child even when seat belt is in use in case of any sudden movement of child causing it to fall off.
- Do not cross the shoulder belts with each other when securing the shoulder belts to the insert plastic. Otherwise excessive pressure may be caused to child's neck.
- Do not use the seat cushion on which rift is found. Otherwise the seat cushion may not function as designed or the child may have chance to swallow the material inside the cushion.
- Seat cushion can play a protective role. When the stroller is not installed with a seat cushion, please stop using the stroller. Otherwise, there may be risk of injury.
- Do not leave the stroller when the child is seated.
- Make sure the open-fold lock is engaged completely before use. Otherwise the stroller may fold suddenly in use.
- Do not let the child operate the front guard. It may make the child to fall off from the stroller.
- Do not allow your child to stand in or on the stroller, it may be dangerous.
- Do not lean on or hang loads on the handle.
- Do not hang parcels or accessory items (except Combi original accessories) on the stroller, otherwise tipping over may happen to stroller.
- Never carry more than one child in the stroller. Do not allow a child to ride or sit on any area other than the seat.
- Excessive weight may cause a hazardous and unstable condition exist.
(Maximum load:15kg. Basket maximum load:5kg)
- Do not use the stroller on stairs.
- Do not let children operate the baby stroller to avoid tipping over or accident.
- Be careful of those around you to avoid pinching their fingers when you are opening or folding the stroller or adjusting the seat angle.



WARNING (Incorrect operation may cause serious injury or death)

- Keep your child's fingers/hands away from moving/folding parts when folding or unfolding or adjusting the stroller.
- Do not apply a lifted seat to baby who cannot sit straight by itself, the most reclined seat must be used.
- When pushing the stroller, please walk slowly to avoid any damage to the stroller swivel wheels or any tipping over.
- Don't let others touch when you open the stroller to avoid accidental injuries.
- The used insert outlet from base seat and the cushion should be matched. (e.g. upper insert outlet of base seat should match with upper insert outlet of cushion) . Otherwise, the shoulder belt may not be long enough to harness the baby.
- It is extremely dangerous to adjust the seat angle when pushing the stroller. Stop the stroller first before operation.
- Mind the road when move the stroller and prevent any wheel get stuck in the gap of the drainage ditch cover(s).
- Never leave the child unattended. It may be dangerous to leave your child unattended.
- Ensure that all the locking devices are engaged before use. Such as adjust your seat belt length, fasten your seat belt correctly and the stroller is fully opened.
- Always use the restraint system to avoid any possible accident.
- Do not use in a reclined angle less than 150° for a child under 6 months old.
- Any loading attached to the handle affects the stability of the stroller.
- Please always fasten the five-point seat belt to ensure the baby's safety.
- Check that the stroller body or seat unit attachment devices are correctly engaged before use.
- This product is not suitable for running or skating.
- Do not let the child play with this product.
- To avoid injury ensure that your child is kept away when unfolding and folding this product.
- Do not place the stroller near fire, high temperature, pool, or electric source.
- Only replacement parts supplied or recommended by the manufacturer/distributor shall be used. Only use original accessories and parts that have been approved by the manufacturer. Do not make any modifications to the product.
- For low-power RF motors that have obtained the type approval, the company, store or user is not allowed to change its frequency, increase its power or change characteristics and functions of the original design without permission.
- Usage of the low-power RF motors must not affect flight safety and interfere with legal communications; if any interference is found, stop using it immediately and improve to clear the interference before continuing to use it. The foregoing legal communication refers to the radio communication operated in accordance with the provisions of the telecommunications laws. Low-power RF motors must tolerate the interference from legal communications or from industrial, scientific and medical motor equipment with radio radiation.
- Excessive collision may cause failure in component.
- Do not charge the Main battery in high temperature (such as in the sun).



WARNING (Incorrect operation may cause serious injury or death)

- To fold the main body, you need to fold the handle first, and then fold the stroller frame.
- Charge the Main battery regularly. Otherwise the function may be failed and cannot be used normally (it is recommended to charge the Main battery at least once every month).
- If the Main battery will not be used for a long time, turn off the power switch of it.
- Do not disassemble the Main battery by yourself or pierce or cut it with a sharp object. Otherwise liquid leakage may be caused.
- If leakage, smoking or burning occur to the Main battery, please keep it away from children, prevent children from touching and contact the after-sales service.
- It is forbidden to throw the Main battery into fire or place it in a high temperature environment. Otherwise an explosion may be caused.
- Children are prohibited from playing with the Main battery to avoid accidents or damage.
- During use, if the rear wheel, Main battery or front pedal is submerged in water completely, the circuit board may be damaged and the functions may be failed. Please stop using functions of the Intelligent Auto-Brake and front pedal light, and contact after-sales service.

 **CAUTION** (Incorrect operation may cause injury or component damage)

- Make sure all snaps are secured when attach the seat cushion to stroller. Otherwise accident or damage to stroller may happen.
- Loosen the shoulder belts and support the backrest with the other hand before lowering the seat angle with a child seated. Do not suddenly change the seat angle while a child is seated.
- Adjust the length of seat belt properly after change of the backrest angle.
- Please do not touch the folding lever except when folding the stroller.
- When opening or folding up the stroller, be careful and avoid the seat cushion, seat belt, blanket and toys, etc., being pinched into the stroller body.
- If one gives excessive shock to the front wheels when getting over the step, stroller may fall down and cause damages. When stepping over, such as a curb, please slow down even a slight difference level, pull downward the handle and step on the foot-step, and make sure to pass the front wheels to get over the step. When going over any step, be cautious of the bumping of the self-supporting rod against the step.
- Never lift the stroller or use it on escalators or stairs when your child is sitting or lying in the stroller.
- This stroller requires regular maintenance by the user.
- Before use, check that the product and all its components have not been damaged during transportation.
- Please do not use the stroller in whatever purposes other than seating a baby. Failure to comply may result in damage of the stroller.
- Do not pull or twist or forcibly press down the front guard hardly. Otherwise the stroller may be damaged.
- Lift the backrest a little to use if the seat is found too narrow when fully reclined. However, the baby should be able to sit straight when stroller is used in such way.
- Do not let an adult sit on the stroller, or add loading on the stroller to avoid any damage to it.
- When used in summer, outdoor weather and road conditions will increase the temperature of the stroller, that using for a long time should be avoided.
- Avoid storing the stroller in places under high temperature, near a heat source or inside a car. Exposure to high temperature may damage or deform the stroller.
- Check regularly that all screws, bolts and nuts are engaged tightly.
- For use on trains:
This product is not designed to be used on trains. When user attempts to use the product at his /her own risk, please lock stopper in case of sudden brake or turning. Otherwise stroller may fall off.
- Do not press on the folding lever while lift the stroller to avoid damage to the part.
- Make sure the basket is empty before folding up the stroller.
- Make sure the canopy is completely folded up before folding the stroller to avoid damage of the parts.
- Do not lay down the stroller and do not put things on the canopy to avoid deformation.

 **CAUTION** (Incorrect operation may cause injury or component damage)

- Do not get hold of an opened front guard to pull the baby stroller.
- Even have stopper, this stroller may also be accidentally slip or overturned.
- Do not leave baby stroller at road side or slope even when it is not in use.
- Do not use the stroller on steep slopes, stairs, escalators, rough roads, beaches, mud, etc.
- When pushing the stroller, please pay attention to any hole or track on the ground to avoid the front wheel from accidentally getting jammed and tipping over.
- In the event of damage or operation problems, stop using the stroller immediately and keep it out of reach of children.
- Never leave the stroller close to stairs or steps.
- In the event of damage or operation problems, please contact customer service center (or local distributor).
- Only use on a flat, relatively smooth, stable and non-slippery surface. Do not use the stroller in snowy, windy days or wet road to avoid the stroller or guardian from slipping.
- Do not use the stroller in lightning days to avoid thunder stroke.
- Do not attach other accessory like buggy board on the main body during a child being carried in stroller, otherwise accident or damage to stroller may happen.
- Do not use the stroller on public vehicles.
- Lift front wheels and pay particular attention to gaps or ditch when crossing rail road and the intersection of the motor road to avoid the front wheels from accidentally getting to jammed and tipping over.
- No continuous use for a long period: Continuous use for a long period of time may exhaust baby. No continuous use of more than 2 hours for a baby in a reclined seat and 1 hour in an upright seat.
- When feel jammed, please do not forcibly fold the stroller to prevent from any damage. You should reopen the stroller to check and operate again.
- Do not put things that are too sharp or too large into the basket since it may cause damage to the basket.
- Please regular cleaning and checking the stroller. Only use neutral detergent to clean the stroller body.
- Make sure no oil or lubricant is left on parts such as front guard or armrest where baby may have chance to lick.
- Please contact customer service center (or local distributor) for replacement if you find the tyre wear seriously affect movement.
- Parking device shall be engaged when placing and removing the children.
- Any load attached to the handle and/or on the back of the backrest and/or on the sides of stroller will affect the stability of the stroller.
- Fasten the safety belt securely, but do not have it too tight.
- Do not hold the front guard to lift the stroller while a child seated. Failure to comply may cause the stroller to fold up suddenly, release the front guard accidentally, or cause the stroller to slip off.



CAUTION (Incorrect operation may cause injury or component damage)

- When traveling on vehicles such as subways / high-speed rails, please mind that the wheels of your baby strollers are not caught by the door, and please mind the gap between the platform and the train.
- When the child's foot comes into contact with the floor or the wheel, stop using the stroller lest it be hurt.
- Do not use in a lying angle if the child's head is beyond the backrest.
- After the Intelligent Auto-Brake is started, be sure to put your hand on the handle light strip. The stroller cannot be pushed normally until the light strip lights in blue.
- The Intelligent Auto-Brake assist system is not applicable to all situations. Therefore, do not rely too much on it.
- When the Intelligent Auto-Brake is off, use the manual brake.
- If rechargeable batteries or a mix of used and new batteries are used in the handle dry cell compartment, the voltage may be insufficient. Using zinc-manganese batteries may cause dry cell leakage and thus damage the dry cell compartment.
- No matter whether the Intelligent Auto-Brake function is activated or not, do not release your hands on a slope to prevent any danger.
- When the handle light is lighting in red, stop using the electronic functions and check the status of the dry cell and the Main battery.
- Follow the instructions of the airline when taking this product along on the aircraft.
- This product generates 2.4GHz frequency band radio wave used by industrial, chemical and medical equipment such as microwave ovens. When there is a equipment using the same frequency band radio wave nearby, radio waves may not be received or transmitted normally.

警告 (錯誤操作可能引致重大傷害或死亡)

不按照本使用說明書指引使用手推車，可能對幼兒造成重大傷害。
幼兒的安全是您的責任。

- 本產品適用於一個月初生兒至15公斤（大約三歲）的幼兒。符合歐洲標準化委員 EN 1888-1:2018安全規定和台灣CNS 12940國家標準。
- 停止手推車時，請使用停車鎖。
- 不論有否承載嬰兒，停車時勿過分信賴停車鎖的性能。
- 即使已使用停車鎖，如載有嬰兒，應隨時留意手推車附近，以防任何危險發生。
- 切勿將小配件放近幼兒，以免幼兒吞下而造成窒息的危險。
- 為了防止幼兒窒息的危險，在拆開包裝後，請將塑膠袋放在兒童接觸不到的地方。
- 過分超載，錯誤摺疊以及使用未經認可的附件會對手推車造成損壞。
- 乘載幼兒時必須繫上安全帶，安全帶包含中央帶，腰帶和肩帶。前護欄不能防止幼兒從座墊上站起來。請確認安全帶沒有鬆脫，以免幼兒突然跌出手推車。
- 為防止幼兒突如其來的動作令其跌出手推車，即使已經扣上安全帶，也請經常留意幼兒，小心使用。
- 肩帶扣在插扣片上時，請勿交叉肩帶，以免肩帶對幼兒頸部造成壓迫。
- 請勿使用已破損的座墊，以免座墊不能發揮其應有功能，或令幼兒誤吞內裡的棉花等。
- 座墊起保護作用，推車未安裝座墊時禁止兒童使用，否則可能有造成傷害的風險。
- 當兒童乘坐時，看護人不要離開。
- 使用前一定要確認開關鎖已鎖上，否則手推車會有突然摺起的危險。
- 不要讓幼兒操作前護欄以免其意外跌倒。
- 不可讓幼兒站立在車上，這是十分危險的。
- 切勿把身體靠於或把重物掛於把手上。
- 切勿懸掛物件 (康貝原廠的配件除外) 於車篷或把手上，以免引致手推車翻倒。
- 切勿承載超過一名幼兒，或讓幼兒坐在座椅以外的地方。
- 承載超重會容易產生不穩定的危險情況，產品最大承載重量：15公斤，置物籃最大承載重量：5公斤。
- 禁止於樓梯間使用手推車。
- 不要讓幼兒操作手推車，以免手推車翻倒或發生其他意外。
- 開關手推車或調節座席靠背角度時要注意四周旁人及小孩，以免夾傷指頭。
- 開關或調節手推車時，請勿讓幼兒的手接觸活動零件部分。
- 對還未能坐直的幼兒，請勿使用直立模式，請以最平躺的角度使用。
- 推動手推車時請勿奔跑，應慢慢步行，以免轉向輪損壞，或引致翻倒等意外。
- 打開幼兒手推車時不要讓他人接觸，以免意外夾傷。
- 在座席使用的肩帶穿孔和座墊的肩帶穿孔位置要一致。如使用座席的上方肩帶穿孔，座墊亦同樣要使用上方肩帶穿孔，不然肩帶有可能因長度不足繫緊幼兒。
- 一邊推行一邊調整座席角度是非常危險的，請勿同時進行。
- 推行時請注意路面狀況，不要讓手推車卡入排水溝蓋的縫隙中。

 **警告** (錯誤操作可能引致重大傷害或死亡)

- 不應在無人照顧下把嬰兒獨留於嬰兒車內，以免發生危險。
- 使用手推車前請確保推車所有鎖定裝置都已處於鎖定狀態，如安全帶長度調整，座墊扣環扣上，推車已完全展開。
- 為了防止意外發生，孩子乘坐時必須繫上安全帶。
- 當靠背角度少於150度時，不適合6個月以下幼兒使用。
- 在把手上放置任何負載都會影響車輛的穩定性。
- 請一直將五點式安全帶扣上，以確保寶寶乘車時的安全。
- 使用前，請先檢查嬰兒車與所有附件已正確安裝。
- 此產品不宜於跑步或溜冰時使用。
- 請勿讓小孩玩耍本品。
- 為避免傷害，當產品在摺疊和展開時，請確保你的孩子遠離產品。
- 使用時應遠離高溫、火源、水池或電源等鄰近範圍。
- 請勿使用未經制造商認可的附屬物。請勿使用非原廠供應的零件替換或自行改裝手推車。
- 經型式認證合格之低功率射頻電機，非經許可，公司、商號或使用者均不得擅自變更頻率、加大功率或變更原設計之特性及功能。
- 低功率射頻電機之使用不得影響飛航安全及干擾合法通信；經發現有干擾現象時，應立即停用，並改善至無干擾時方得繼續使用。前項合法通信，指依電信法規定作業之無線電通信。低功率射頻電機須忍受合法通信或工業、科學及醫療用電波輻射性電機設備之干擾。
- 主控模塊過度碰撞可能造成部件故障。
- 禁止在高溫環境下（如太陽暴晒下）對主控模塊進行充電。
- 收摺車體要先摺疊把手，再將車架摺疊，如不先摺疊把手，手把落下可能碰到地面或碰到兒童。
- 主控模塊請定期充電，否則可能導致機能失效，不能正常使用（建議每使用一個月至少充一次電）。
- 如長時間不使用時，請將主控模塊的電源開關關閉。
- 請勿私自分解主控模塊或用尖銳物刺穿，剪切，否則可能導致漏液。
- 如主控模塊產生漏液，冒煙或燃燒等，請遠離兒童，防止兒童接觸，並聯繫售後。
- 禁止將主控模塊丟入火中或置於高溫環境，否則可能發生爆炸。
- 禁止兒童玩耍主控模塊，以免引致意外或造成損壞。
- 使用時，如果將後輪，主控模塊或前腳踏板全部淹沒在水中，可能會導致電路板損壞，功能失效。請停止使用自動剎車及前腳踏板功能，並聯繫售後。

注意 (錯誤操作可能引致受傷或元件損壞)

- 安裝座墊時，請確保所有帶扣等已經裝好，以免引致意外或造成損壞。
- 在已承載幼兒的狀態下調整座席角度時，請先將肩帶調鬆，然後以另外一隻手支持著靠背調節，請注意勿讓座席角度突然改變。
- 調整座席角度後，請重新調整安全帶至適當長度。
- 除開摺手推車外，請勿觸碰開關掣。
- 當打開和收摺推車時，請注意及避免可裝拆的座墊、手推車的安全帶、被子及玩具夾在手推車車體上。
- 當越過不同段差時，若強行附加力量於前車輪上使之與段差碰撞，可能引起手推車損壞和故障，當越過段差時，即使是微小段差區的地方也應減緩推行，並踏上後腳支桿及往後按下把手往前行，確保前車輪越過段差才可通行。推行時請注意自立桿和段差台的碰撞。
- 當幼兒乘坐時，請勿在手扶梯上使用或搬動手推車。
- 使用者必須對本產品作定期保養。
- 每次使用前請檢查配件是否在運輸過程中被損壞。
- 請勿將手推車作承載幼兒以外的用途，否則會引致損壞。
- 請勿用力拉動、扭動、壓下前護欄，以免引致損壞。
- 假如放低椅背使用時座位太窄，可以將靠背調高一點使用。但注意幼兒應已差不多能獨自坐直，才可這樣使用。
- 請勿讓成年人坐上手推車，或在上面放置重物，以免損壞手推車。
- 夏天使用時，戶外的天氣和路面情況會令手推車溫度提高，應避免連續長時間使用。
- 避免將手推車存放於高溫，接近熱源的地方或車廂內，因高溫可使手推車損壞或變形。
- 請定期檢查所有螺絲、螺栓和螺母是否拧紧。
- 有關火車上的使用：
本產品並非以火車上的使用為目的所設計的產品。假如閣下自行決定於火車上使用，請小心注意，並鎖上停車鎖，以免轉彎或剎車時令手推車翻倒。
- 請勿在提起手推車的狀態下按下開關掣，以免引致元件損壞。
- 收起手推車前請先確認置物籃內的物品已取出。
- 收摺前請先確認車篷已經完全收起，以免引致組件損壞。
- 收起手推車時，請避免橫放，或於上面置放重物，以免車篷變形。
- 請勿手執開放的前護欄來拖動手推車。
- 即使已經鎖上停車鎖，手推車也有可能意外滑動或翻倒。
- 即使幼兒不在車上，也不可將手推車隨意放在路旁或斜坡等危險地方。
- 不可於斜坡、階梯、自動扶梯、顛簸坡道、沙灘、泥地等場所使用手推車。
- 推動手推車時請小心路上凹陷之地方，以免前輪意外陷進溝內令手推車翻倒。
- 如手推車出現損壞或操作問題，應立即停止使用，並將其存放在遠離幼童的地方。
- 請勿將本產品放近樓梯或梯級上。
- 只可在乾燥的平地上使用。請勿於雪地和強風時或濕滑路面上使用，以免令手推車或監護者意外翻倒。
- 如發現手推車損壞或有操作問題，請聯絡客服中心（或當地經銷商）。
- 請勿於打雷時使用手推車，以免意外遭受雷擊。
- 請勿外加任何以輪板或元件於主體上承載幼兒，以免發生意外或對手推車造成損壞。
- 請勿於公共汽車上使用手推車。

注意 (錯誤操作可能引致受傷或元件損壞)

- 跨越火車軌和汽車道的十字道口等時，請提高前輪跨越間隙，以免前輪意外卡在溝內引致翻倒。
- 禁止連續長時間使用：連續長時間使用會對幼兒造成負擔。躺臥姿勢的連續使用時間上限為2小時，坐著姿勢的則為1小時。
- 感覺有異物卡住時，請勿強行摺疊，以免造成損壞。應先打開手推車，確認後再操作。
- 請勿承載太尖或太大的東西於置物籃中，以免置物籃損壞。
- 請定期清潔以及檢查手推車。請勿使用非中性的清潔劑清潔車架。
- 請注意勿讓油分附在幼兒有機會舔到的地方，如前護欄，扶手等。
- 如發現車輪外胎磨耗嚴重，影響推行，請聯繫客服中心(或當地經銷商)進行更換。
- 當放置和移開幼兒時請鎖定停車裝置。
- 為了手推車的穩定性，請勿將其他產品連接到推把、靠背的背部、手推車的側面等部位。
- 請牢牢繫上安全帶，但注意不要過緊。
- 切勿搬動承載了嬰孩的手推車，以免手推車突然收摺。或手執前護欄等地方搬動手推車，以免手推車意外滑脫或令前護欄松脫以致手推車掉下。
- 在乘坐如地鐵/高鐵等交通工具時，請注意手推車的車輪不要被車門夾住，並請留意站台和車之間的縫隙。
- 當幼兒的腳接觸到地面和車輪時，請勿使用手推車，有可能造成腳受傷。
- 假如幼兒頭部超出靠背前端時，請勿使用躺臥角度。
- 啟動電動剎車後，手必需放在把手燈帶上，燈帶藍燈亮起後才能正常推行。
- 自動剎車輔助系統不是所有情況都適用，請不要過份依賴自動剎車輔助系統。
- 自動剎車關閉時，請使用手動剎車。
- 把手電池倉如使用充電電池或新舊電池混用，可能會導致電壓不足，使用鋅錳電池可能導致電池漏液損壞電池倉。
- 無論電動剎車功能是否啟用，在斜坡請勿鬆開雙手，以防任何危險發生。
- 把手紅燈亮起，請停止使用電子功能，並檢查乾電池和主控模塊狀態。
- 攜帶本產品乘坐飛機時，請遵從航空公司的指示。
- 本產品會產生微波爐等工業、化學、醫療設備等所使用的2.4GHz頻段電波。當附近有使用相同頻段電波的產品時，可能會無法正常收發電波。

List of components 部件清單

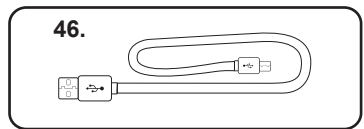
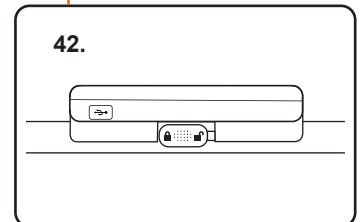
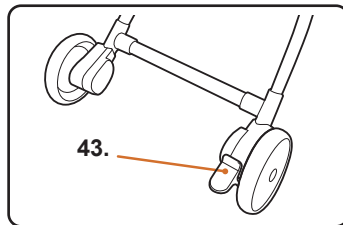
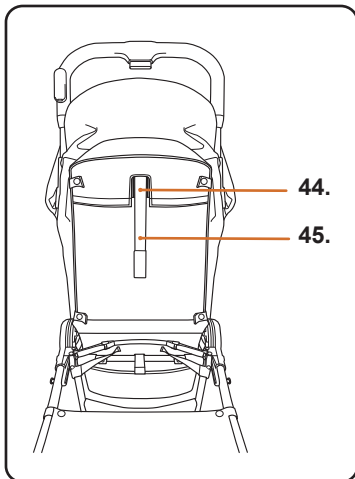
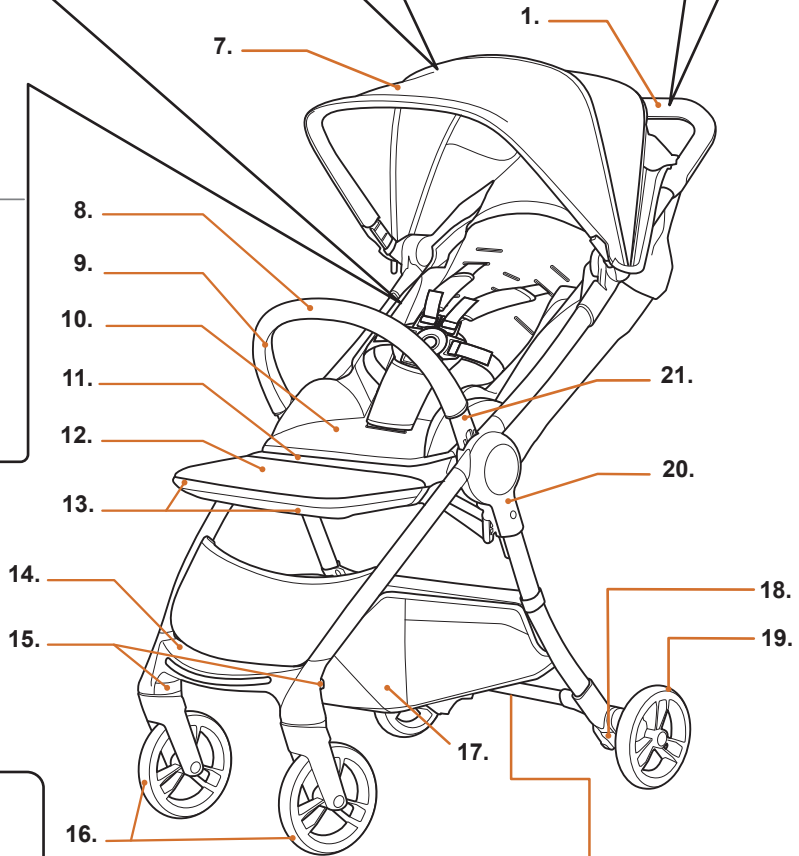
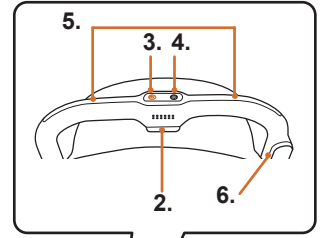
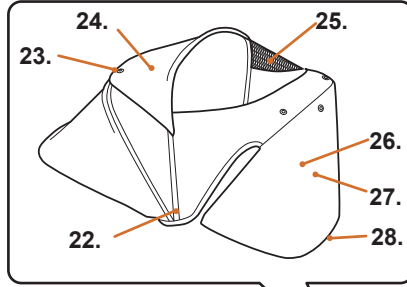
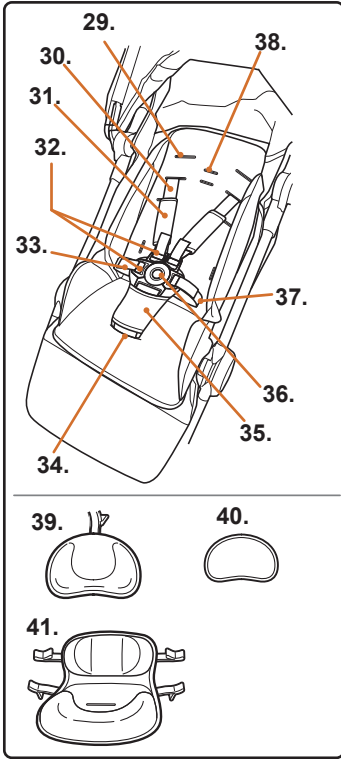

List of components

- | | | |
|-------------------------------------|--------------------------------|-------------------------------|
| 1.Handle | 16.Front wheel | 31.Shoulder belt cover |
| 2.Handle folding button | 17.Basket | 32.Shoulder/Waist belt buckle |
| 3.Intelligent Auto-Brake button | 18.Rear wheel | 33.Waist belt |
| 4.AuraBeam button | quick-release button | 34.Crotch belt |
| 5.Touch panel | 19.Rear wheel | 35.Crotch belt cover |
| 6.Handle battery compartment | 20.Folding lever | 36.Crotch belt buckle |
| 7.Canopy | 21.Front guard buttons | 37.Waist belt insert outlet |
| 8.Front guard cover | 22.Zipper | 38.Head support insert outlet |
| 9.Front guard | 23.Snap | 39.Head support |
| 10.Seat cushion | 24.Top window cover | 40.EggShock pad |
| 11.Folding belt | 25.Top window | 41.Body/Hip support |
| 12.Adjustable foot support | 26.Airthrough window | 42.Main battery |
| 13.Adjustable button | 27.Airthrough window cover | 43.Stopper |
| 14.Step | 28.Back-view skylight zipper | 44.Reclining cord |
| 15.Front wheel quick-release button | 29.Shoulder belt insert outlet | 45.Seat reclining buckle |
| | 30.Shoulder belt | 46.Micro-USB Charging cable |

部件清單

- | | | |
|-----------|-----------|--------------|
| 1.把手 | 17.置物籃 | 33.腰帶 |
| 2.手把摺疊按鍵 | 18.後輪快拆按鈕 | 34.中央帶 |
| 3.智能剎車鍵 | 19.後輪 | 35.中央帶套 |
| 4.前燈鍵 | 20.開關掣 | 36.中央帶扣 |
| 5.感應燈帶 | 21.前護欄鬆脫掣 | 37.腰帶穿孔 |
| 6.把手電池盒 | 22.車篷拉鏈 | 38.護頭墊穿孔 |
| 7.車篷 | 23.車篷天窗鈕扣 | 39.護頭墊 |
| 8.前護欄套 | 24.天窗蓋 | 40.EggShock墊 |
| 9.前護欄 | 25.透氣窗 | 41.護背連臀墊 |
| 10.座墊 | 26.後視透氣天窗 | 42.主控模塊 |
| 11.收車拉帶 | 27.後視天窗蓋 | 43.停車鎖 |
| 12.可調節腳托 | 28.後視天窗拉鏈 | 44.靠背角度調節帶 |
| 13.可調節按鈕 | 29.肩帶穿孔 | 45.靠背角度調節扣 |
| 14.腳踏 | 30.肩帶 | 46.USB充電線 |
| 15.前輪快拆按鈕 | 31.肩帶套 | |
| 16.前輪 | 32.肩腰帶插扣片 | |

Checking the sales package 開箱確認

Check if any part is missing after opening the sales package.
(Full list of parts please refer to the picture provided.)

請於開封後確認所有部品是否齊全。
(完整圖內容物如右圖)。

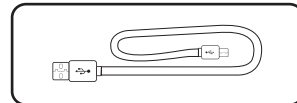
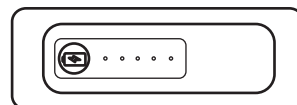
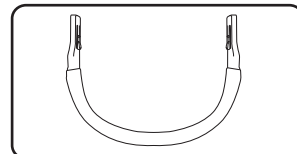
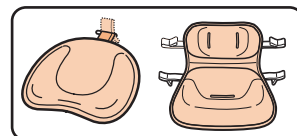
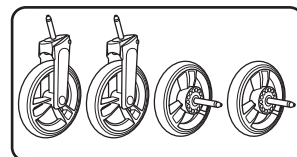
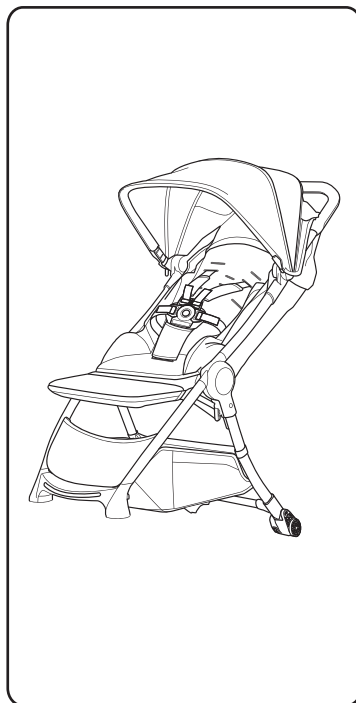

Unfolding the stroller 打開手推車

Unfold the stroller frame by holding and lifting the handle. The folding lever button pops up until a clear “click” sound is heard, indicating that the stroller is unfolded completely.

CAUTION: Ensure that all the locking devices are engaged after open the stroller.

握住把手往上提即可展開車架，收車開關擊彈出，直到聽到一聲清晰的“咔嚓”聲，表示手推車完全展開。

注意：打開手推車後，請確認開關鎖已經完全處於鎖定位置。

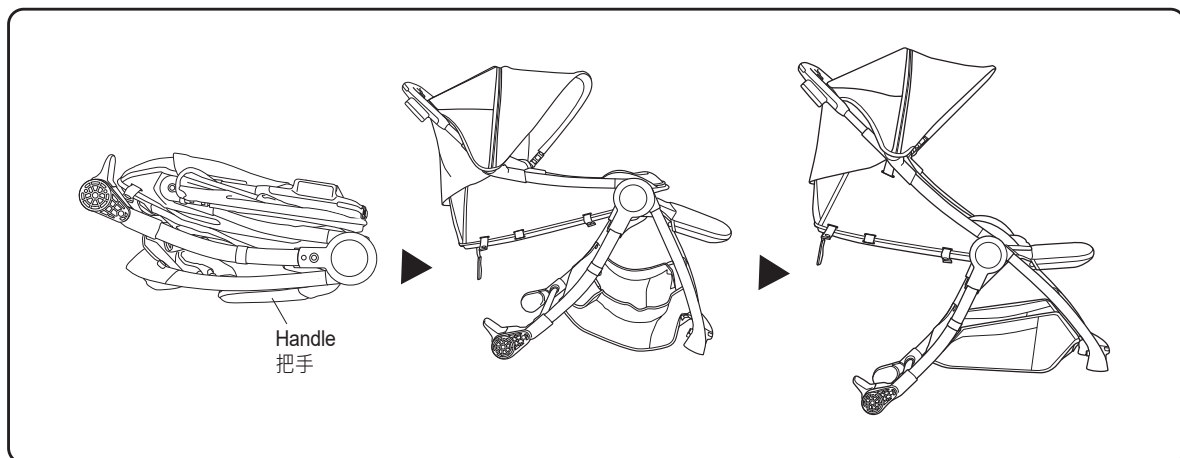

Installation and removal the swivel wheels 安裝/拆卸方向輪

Rear wheel installation/removal

Rear wheel installation

Lift the rear wheel seat and insert the rear wheel metal plug into the mounting hole until a clear "click" sound is heard, indicating that the rear wheel is in place. Install the rear wheel on the other side in the same way.

Rear wheel removal

Press the removing button on the inner side of the rear wheel seat to remove the rear wheel.

Front wheel installation/removal

Front wheel installation

Lift the front wheel tube and insert the front wheel metal plug into the mounting hole until a clear "click" sound is heard, indicating that the front wheel is in place. Install the front wheel on the other side in the same way.

Front wheel removal

While pressing and holding the quick-release button on the front wheel, press to remove the front wheel.

WARNING : Once the wheels are installed, pull the wheels outward to check whether they are firmly installed.

後輪的安裝/拆卸

後輪的安裝

提起後輪座，將後輪金屬插頭插入安裝孔，直到聽見一聲清晰的“咔嚓”聲，表明後輪安裝到位，用同樣的方式安裝另一邊的後輪。

後輪的拆卸

按住後輪座內側拆卸按鍵，即可拆卸後輪。

前輪安裝/拆卸

前輪安裝

提起前輪管，將前輪金屬插入安裝孔，直到聽見一聲清晰的“咔嚓”聲，表明前輪安裝到位，用同樣的方式安裝另一邊前輪。

前輪拆卸

按住前輪上面的快拆按鈕，按下即可拆卸前輪。

警告：車輪安裝後，請務必向外拉扯車輪以確認車輪是否安裝牢固。

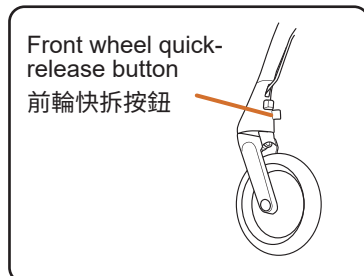
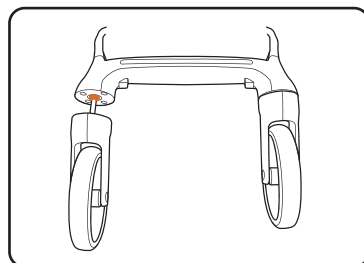
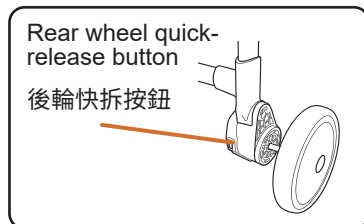
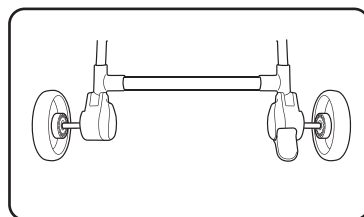

Using the stopper 使用停車鎖

Using the stopper

- To lock rear wheels, press the stopper down which is located at rear right wheel. Try to push the stroller back and forth slightly to ensure that the stopper is properly engaged.
- To unlock lift the stopper

WARNING : Always engage the stopper when you leave the stroller.

停車鎖的使用

- 如圖向下踩下停車鎖按鈕直到聽到「咔嚓」聲。輕輕前後推動推車，確認停車鎖已鎖定。
- 如需解除，將停車鎖上撥即可。

警告：在遠離手推車時，請時刻謹記使用停車鎖。

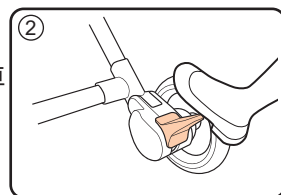
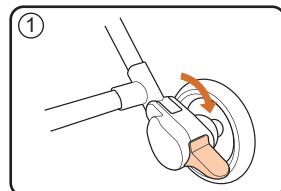

Using the foot support 使用腳托

Foot support

Pressing the two built-in buttons at the same time can adjust the foot support angle in two gears at any time.

WARNING : No standing or sitting on the foot support area.

腳托

同時按下前端內置兩個按鈕可以上下兩個檔位隨時調節腳托角度。

警告:腳托區域禁止站立及坐立。

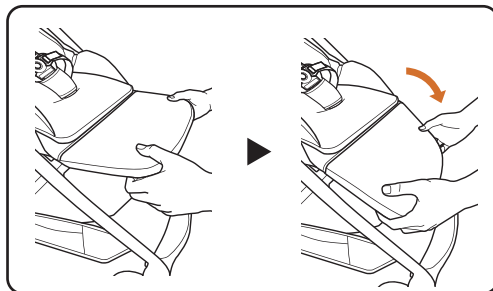

Using the front guard 使用前護欄

- To open the guard press and hold the button at the end of the front guard as illustrated. Detach the front guard.
- To install the guard, align the front guard to the socket and insert it. Pull the guard to check whether it is securely locked.

WARNING : Do not use the front guard to move the stroller while a child is seated. After detaching the front guard, do not push or bend the front guard.

- 按下圖①中箭頭所指處的前護欄鬆脫掣按鈕(兩邊),抽起前護欄。
- 要扣上護欄時,如圖②請將前護欄對準插口,然後插入安裝。用手拉一拉確認是否鎖定牢固。

警告:小孩乘坐時,請勿手執前護欄搬動手推車。拆下前護欄,不能將前護欄向外張開及向內按壓。

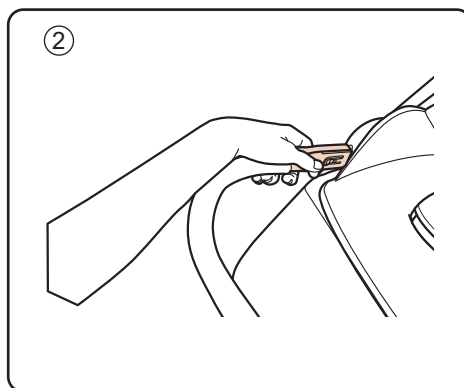
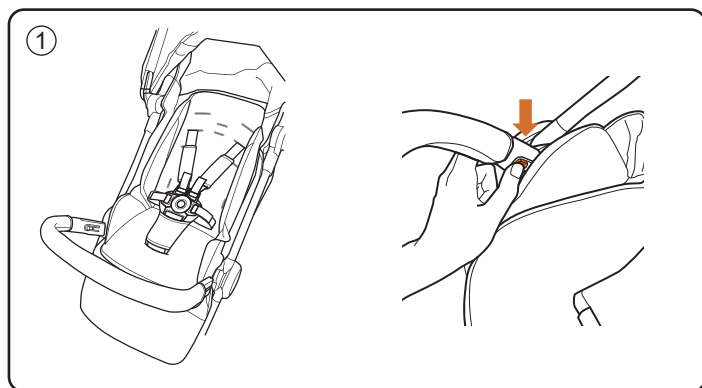

Detach the front guard cover 拆除前護欄套

Release the front guard and detach the cover from the front guard.

打開前護欄,從護欄上取下護欄套。

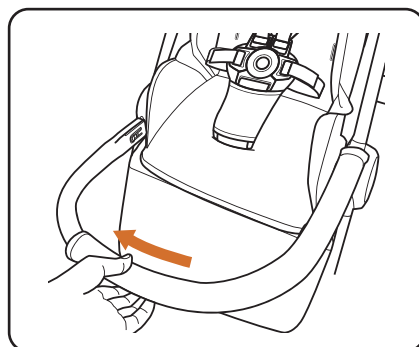

Adjusting the covering size of canopy 車篷大小的調節

- The canopy supports two-piece and three-piece adjustment. Once the zipper is unzipped, three-piece adjustment is available.
- To reduce canopy coverage, hold the front rod of canopy and pull the canopy backward.
- For full coverage, hold the front rod of canopy and pull the canopy forward.
- 車篷可調節為二片調節和三片調節，將拉鍊拉開之後為三片調節。
- 收攏車篷，用手拉住車篷前支桿向後調節。
- 展開車篷，用手拉住車篷前支桿向前調節。

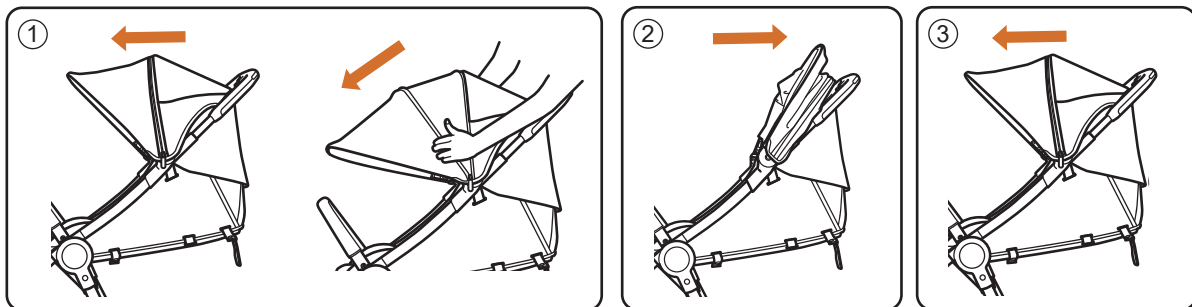

Using the Top window 使用天窗

Open top window by releasing snap.
打開天窗時請將鈕扣解開，將天窗蓋子向後翻開即可。

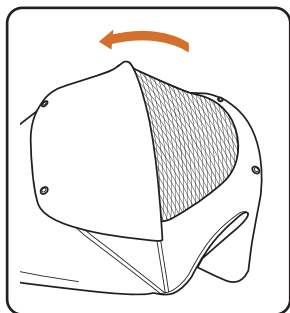

Close the window by fastening the snap.
關閉天窗時則將扣子重新扣上即可。

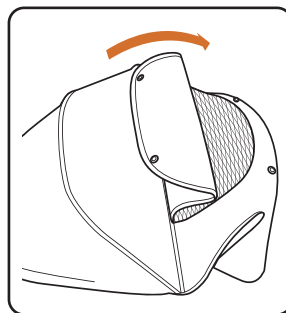

Using the airtrough window 使用透氣窗

Unzip the zips on both sides at the back of the canopy.
解開車篷後兩邊的拉鍊。

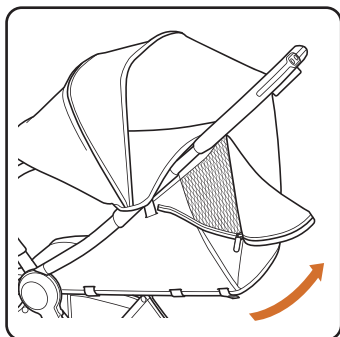

Roll up the canopy cover at the back end. Buckle it up.
將後車篷蓋往上卷，扣上卡扣。

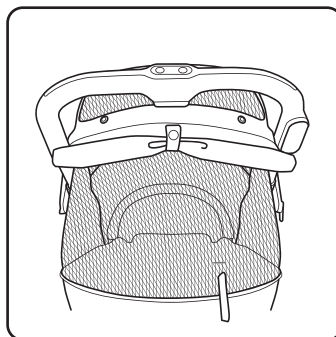

Using safety harness 使用安全帶

- ① Seat the child into the stroller and fit the shoulder belts on the child's left and right shoulder.
- ② Shoulder and waist buckles are overlapped.
- ③ Pull out the crotch belt and put the insert plastics into the buckle until a "Click" sound is heard. Pull the shoulder belts, waist belts and crotch belt to check if it is secured.
- ④ Press the crotch buckle button to release the harness.

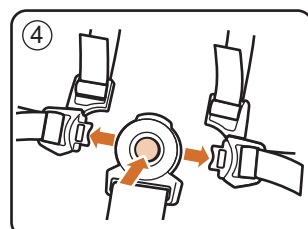
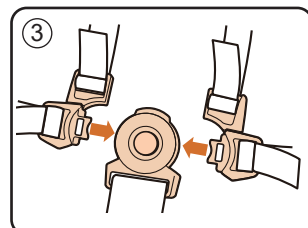
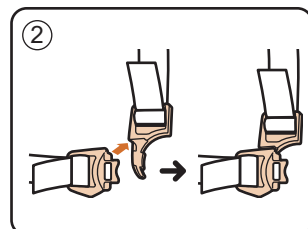
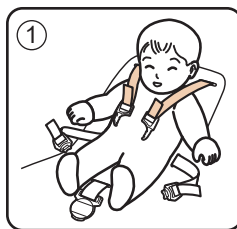

WARNING : Always use the restraint system.

Note : Adjust the length of seat belt properly after change of the backrest angle.

- ① 讓孩子坐在車內，使其肩膀左右與肩帶貼合。
- ② 將肩帶扣和腰帶扣重疊。
- ③ 拿起肩腰帶扣左右插入中央帶扣，聽到“咔嚓”一聲。拉動中央帶，腰帶和肩帶確認有無鬆動。
- ④ 若要解開安全帶，按下中央帶扣中間的按鈕即可解除。

警告：任何時刻都必須使用安全帶。

小提示：當改變靠背角度時，請謹記檢查並確認安全帶已作出最適當的調整。

Adjusting the waist/shoulder belt length 調節肩帶、腰帶的長度

- To shorten, pull the waist belt end as shown direction A.
- To lengthen, loose and pull out the waist belt as shown direction B, then pull it inward to extend the length as shown direction C.
- Use the same method on waist belt to adjust the shoulder belt.

NOTE: Always leave at least 3cm at the belt end.

- 收緊時，將腰帶的前端位置往圖標箭頭A方向拉。
- 延長時，將腰帶外側往B箭頭方向鬆脫出來，然後再將腰帶向內側往C箭頭方向拉。
- 肩帶的調節方法同腰帶的調節方法一致。

小提示：注意腰帶末端應留下3cm以上的長度。

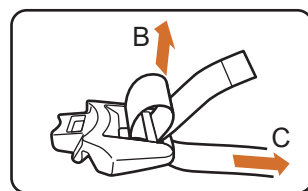
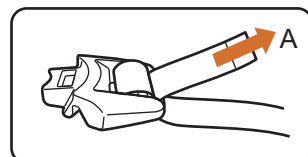

Adjusting the crotch belt 調節中央帶時

- Tightening – Pull the crotch belt end as shown direction (A).
- Extending – Follow the direction (B) of arrow and pull out the belt to end.
- Follow the direction (C) and pull the belt to the end.
- 收緊中央帶時，如圖 (A) 拉出中央帶內側的安全帶到最末端。
- 延長時，如圖 (B) 箭頭方向拉出中央帶末端安全帶後按照圖 (C) 箭頭方向拉到底。

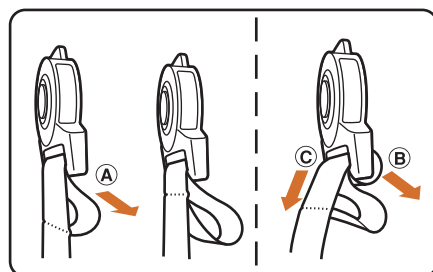

Attaching the insert plastics 將肩帶、腰帶裝到插扣片上

① Use the waist belt end to pass through from the buckle back slot ③ and slide out to slot ①.

② Pull out the waist belt end from slot ②.

③ Slide out the waist belt end through slot ③.

④ Pull out the waist belt from slot ① and adjust the applicable length. (Leave 3cm or above)

① 將腰帶前端從穿孔 ③ 穿出再通過孔 ① 拉出。

② 將腰帶前端通過穿孔 ② 拉出。

③ 將腰帶前端再向穿孔 ③ 通過。

④ 最後將腰帶向穿孔 ① 拉出，並調至到合適的長度。(末端保留3cm以上)

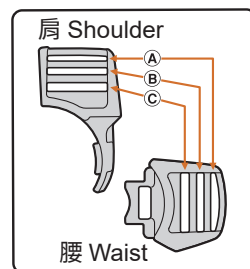
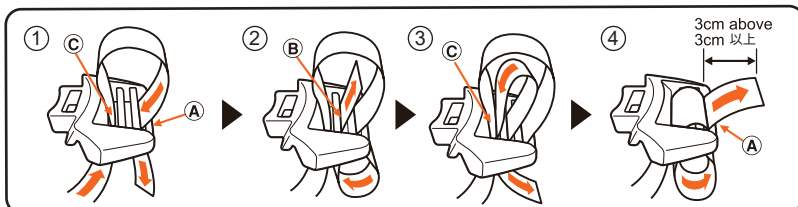

Reclining the backrest 調節靠背角度

• Upright – As shown in figure 1, support the backrest with one hand, then pull up the reclining belts until the angle is adjusted.

• Recline – As shown in figure 2, open the reclining buckle then adjust the reclining angle.

• 如圖 ① 調高靠背角度時，先以單手支撐著靠背，將調節帶向上拉去調節合適的角度。

• 如圖 ② 調低靠背角度時，打開調節扣去調節角度。

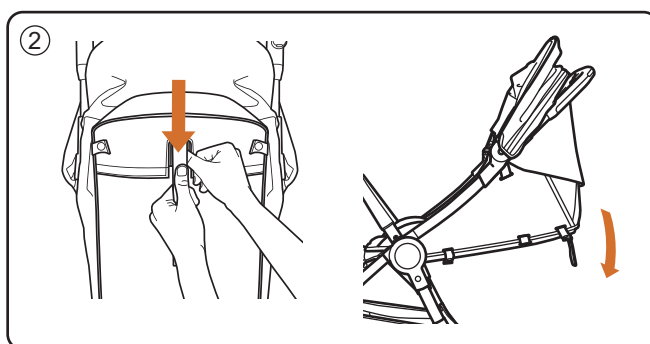
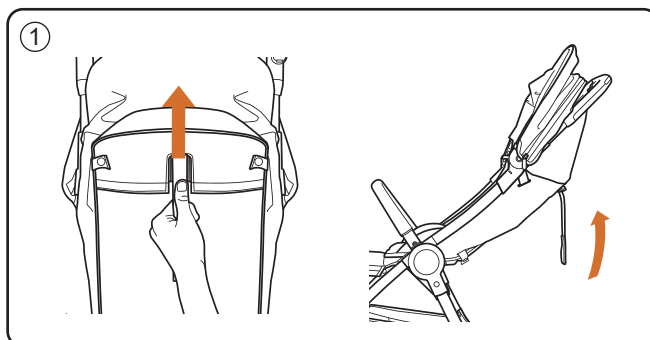

Folding the stroller 收摺手推車

- ① Press the handle folding button to fold the handle forward when folding the stroller.

WARNING : Make sure that the handle folding joint is folded completely.

- ② Fold the handle forward and press the grey folding lever for stroller retraction.

WARNING : The folding lever on the right side of the stroller does not protrude, indicating that the folding lever has been unlocked.

- ③ Pick up the folding stroller with folding belt.

WARNING : When folding the stroller, please ensure your child and other children are kept at a safe distance. Please ensure that they are not in contact with moving parts and remove all items from the basket before folding the stroller.

Note : Tuck up the canopy and the backrest before folding up the stroller.

Note : Stroller folded up in this way can be towed, making the movement more effortless.

- ① 收車時按下手把摺疊按鍵將手把向前摺疊。

警告：確認把手摺疊關節確實摺疊到位。

- ② 手把向前摺疊後，按下收車開關掣。

警告：車體右邊的收車開關掣沒有凸出來，表示開關掣已經解鎖。

- ③ 提起收車拉帶摺疊嬰兒手推車。

警告：在收摺手推車時，請確保與幼兒保持安全的距離，請勿讓幼兒觸及活動零件，並從置物籃中取出所有物品。

小提示：摺疊手推車前請先將車篷和靠背收攏。

小提示：此摺疊方法方便拖行，不必整車拎起，出遊更輕鬆。

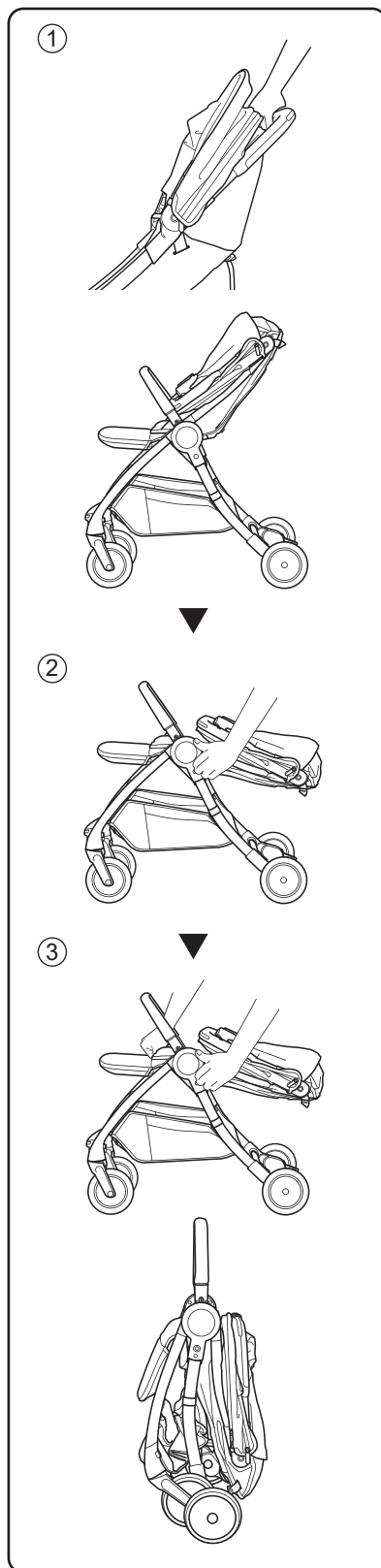

Basket 置物籃

- The basket can carry a maximum weight of 5kg.
- You can attach and remove the belts and snaps according to step ①, ②, ③, ④.

CAUTION : Never place any glassware or fragile objects in the basket lest they be damaged. Place the objects in the basket as evenly as you can, thus making them bear even load.

CAUTION : When moving up steps, please lift the front or rear wheels of the stroller to prevent its basket below from touching the ground.

- 置物籃的最大載重量是5kg。
- 使用安裝帶並按照①, ②, ③, ④安裝或拆除置物籃。

注意：玻璃製品和易碎物品請不要放入置物籃中，以免物品破損。請盡可能的讓物品均勻的放入置物籃中，使其受重均勻。

注意：過段差台時，請抬高前輪或後輪，避免置物籃與地面的接觸。

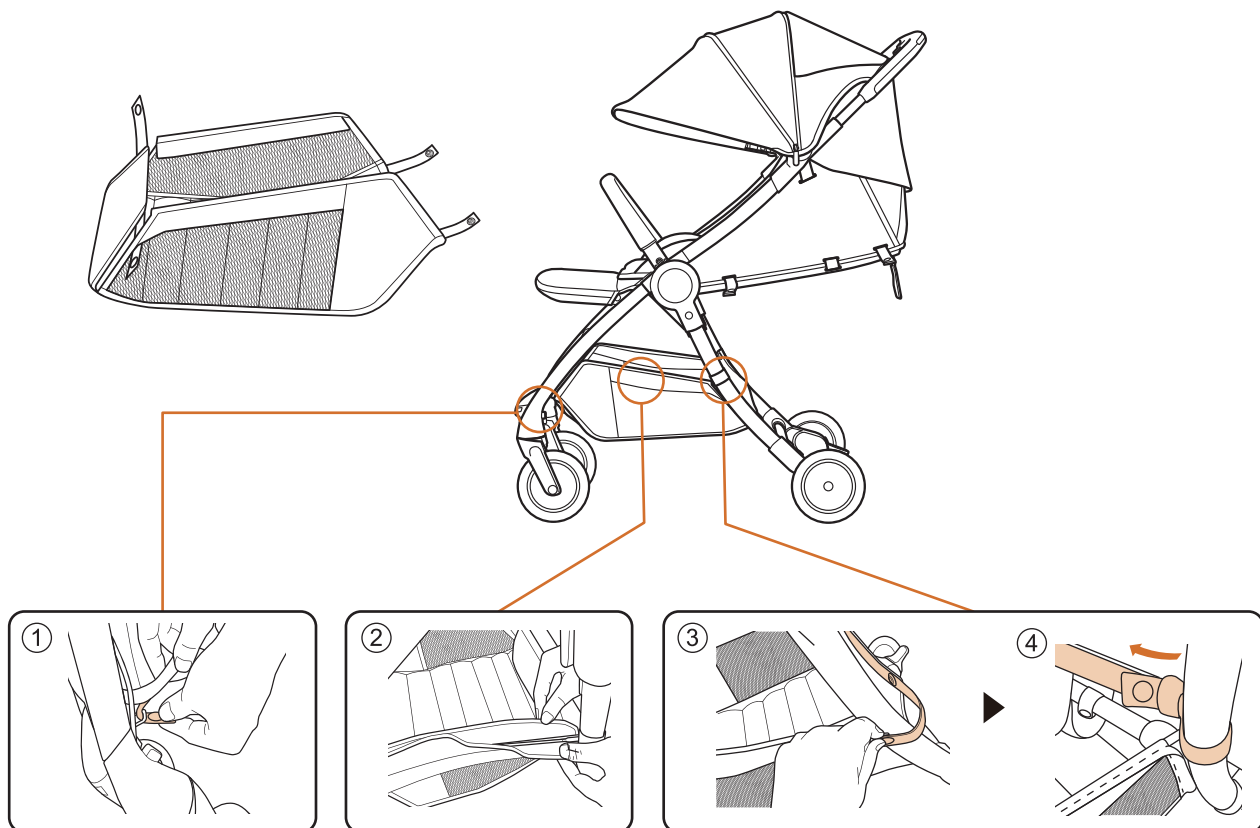

Detaching the seat cushion 座墊的拆除方法

- ① Press on the buckle button to release the insert plastics.
- ② Remove shoulder belt cover and crotch belt cover if fitted.
- ③ Unfasten snaps on both sides of the seat cushion (2 places).
- ④ Pull out crotch belt from seat cushion.
- ⑤ Loosen the snaps (upper) on both sides of seat cushion from seat back (4 places).
- ⑥ Remove waist belt and shoulder belt, then remove seat cushion from backrest.

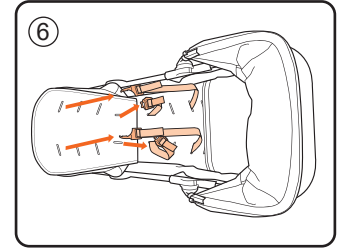
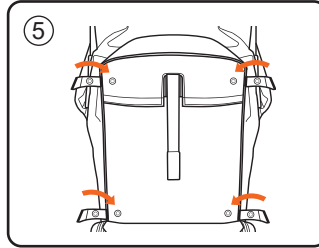
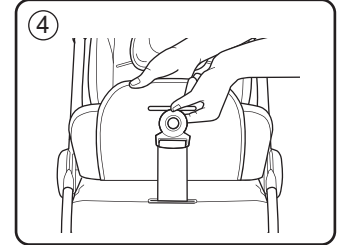
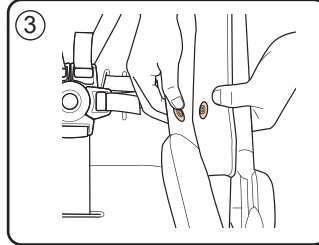
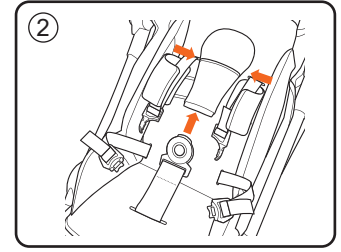
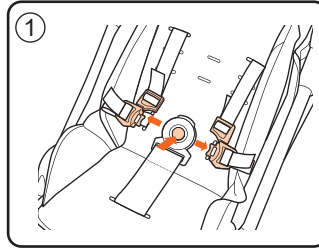

To install seat cushion, go in the reversed steps.

WARNING: Make sure the seat cushion has been correctly attached before use.

- ① 按下安全帶扣按鈕，將插扣片從安全帶扣解下。
- ② 如若配戴了肩帶套和中央帶套請先一併拆下。
- ③ 將座墊兩側的扣子解開 (2處)。
- ④ 將中央帶從坐席拉出。
- ⑤ 將座墊上部的扣子從靠背上解開 (4處)。
- ⑥ 將肩帶、腰帶從座墊抽出，然後將座墊抽出。

安裝時請以逆序進行。

警告：使用手推車前務必確認座席已正確安裝。

Adjust the length of shoulder belt 調節肩帶高度

- ① Release the shoulder belt from the seat cushion and backrest (after the rear velcro is released, pull the buckle inside the seat sleeve outward).
- ② Insert the shoulder belt through the correct slots on the seat cushion, make sure you use the slots in the same height.

Note : The lowest shoulder belt insert outlet should be used for children under 6 months.

- ① 先將肩帶從座墊及靠背 (後面的魔鬼氈打開後，從座套內的釦子往外) 解除。
- ② 將肩帶穿過座墊上正確對應位置的穿孔，並確認兩邊穿孔在適當的高度。

小提示：當幼兒未滿六個月時，請使用最低的肩帶穿孔。



Attaching the crotch belt cover 安裝中央帶套

Pull the crotch belt through crotch belt cover, pull out the buckle button.
如圖將中央帶穿入中央帶套中，然後拉出中央帶扣。

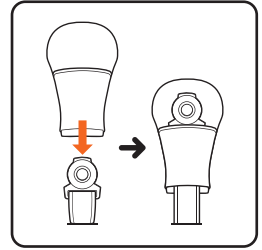

Attaching the shoulder belt cover 安裝肩帶套

When the shoulder buckle is unlocked, place the shoulder belt cover onto the shoulder belt and buckle it up.
肩帶扣打開後，將肩帶套安裝到肩帶上，並扣上釦子。

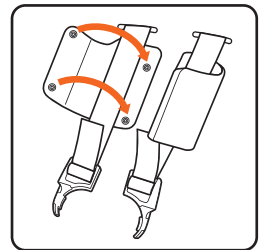

Installing the Dacco cushion 懷抱型座墊的安裝方法

- Correct position of head support - The cushion pad of the head support should just touch at the child's neck.
- Below is the age reference of using Dacco cushion.
- 護頭墊的安裝位置。護頭墊部分，應該剛剛抵幼兒頸部。
- 懷抱型座墊的參考安裝時期。

	1Month 1個月	Starting to sit without aid (7 Months) 獨自乘坐前期(7個月)	36Month 36個月
Head pad 護頭墊	←————→		
EggShock pad EggShock 墊	←————→ Attached in the head pad 放在護頭墊中使用		
Body & Hip support 護背連臀墊	←————→		

※ Indicated age for reference only , please apply according to child's body size.

※ 月齡只作參考，請依照幼兒體格判斷後使用。

Installing the head support 護頭墊的安裝方法

Loop the head support belt through the head support hole, the belt is tipped opposite through the hole to attach. After it is installed, check if it is well secured to the movable seat cushion or not by slightly pulling.

Reference for head support insertion outlets (A) (B)

(A) for child from around 1 month to 4 months.

(B) for child from around 4 months to 7 months.

透過護頭墊孔通過護墊帶，將護墊帶摺回繞過穿孔安裝。安裝後，輕輕的拉動檢查它是否固定在可移動的座椅。

有關護頭墊穿孔的 (A) (B) 參考

(A) 大約供1個月至4個月的幼兒使用。

(B) 大約供4個月至7個月的幼兒使用。

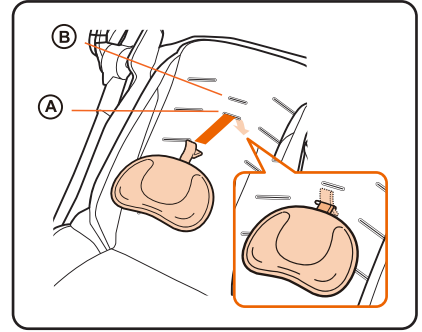

Installing Body & Hip support 護背連臀墊的安裝方法

- Using the supporting belts (upper position) of the Body & Hip support to pass through the holes of the seat cushion body support location. To fix the supporting belts by opening the tail at the end.
- Using the supporting belts (upper position) of the Body & Hip support to pass through the holes of the seat cushion hip support location. To fix the supporting belts by opening the tail at the end.
- The both sides of waist belts pass through the upper holes of the Body & Hip support.

WARNING : If the body & hip support does not fit the baby even the baby is under age of 3, please do not use the body & hip support. To detach it, please follow the reversed steps.

- 將護背連臀墊護背上的護墊帶穿過座椅上的身體護墊帶穿孔。將支援帶的尾部打開去固定支援帶。
- 將護背連臀墊護臀上的護墊帶穿過座椅上的臀部護墊帶穿孔。將支援帶的尾部打開去固定支援帶。
- 請用護背連臀墊護背上的穿孔穿上腰帶；用護臀上的穿孔穿上中央帶。

警告：即使幼兒是3歲以下若護背連臀墊不適合幼兒體格，請立即停止使用。拆除時，以相反的安裝步驟拆除。

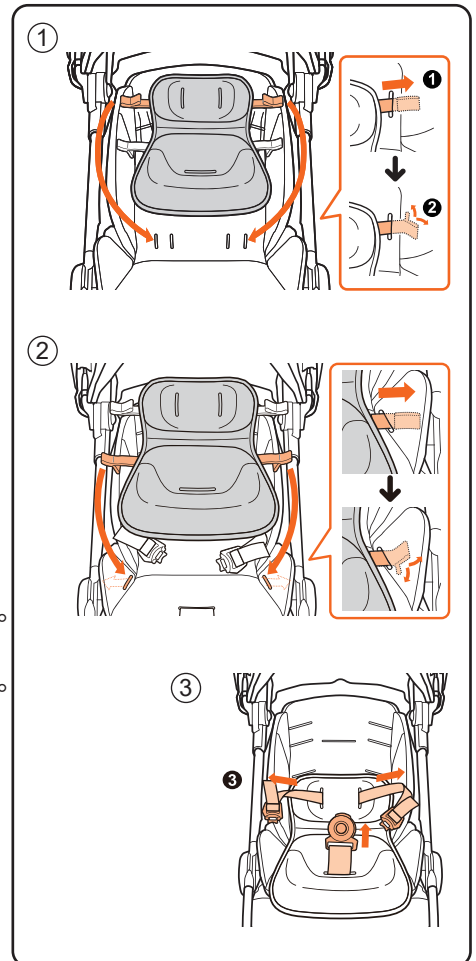

Regarding Intelligent Auto-Brake assistant device 關於自動剎車輔助系統

This product is a stroller with Intelligent Auto-Brake assistant device. The Intelligent Auto-Brake function can identify whether the stroller handle is held, so that it can break and stop automatically in case of accidental release of grab.

WARNING : In using the Intelligent Auto-Brake function, if any of the following conditions occurs, accidents may be encountered due to abrupt locking of the brake.

- Any parts other than the touch panel of the handle, such as the frame, the seat surface, the front guard and the hood, is held when you push the stroller.
- The stroller is pushed when the width of your hand in touch with the touch panel is about one finger wide.
- The stroller is pushed by holding the handle with something like a thick cloth or the stroller cover covering the touch panel.
- Only the inner part of the handle, instead of its touch panel, is touched in pushing the stroller.
- Only the central part of the handle where the button is located is held in pushing the stroller.

WARNING : In using the Intelligent Auto-Brake function, if any of the following conditions occurs, accidents may be encountered as the brake may fail to start properly.

- Do not cover the Intelligent Auto-Brake, AuraBeam button and the handle touch panel with the stroller cover.
- Do not hang metal sheet on handle.
- Do not hang a wet towel on the handle.
- Please do not place smart gloves and other high conductivity items on the handle.

本產品是附帶自動剎車輔助裝置的嬰兒手推車。

自動剎車能夠自動識別是否握住車身把手，即使出現誤脫手的情況，也能夠自動剎停。

警告：當使用自動剎車功能時，如果誤採用如下使用方法，可能會因剎車突然自動鎖死而導致意外事故。

- 推動手推車時握住了把手感應燈帶之外的部分，例如嬰兒手推車車架以及座椅的座面、前護罩、車篷等。
- 在約有一根手指的寬度接觸到感應燈帶的狀態下推動嬰兒手推車。
- 用厚布或是車罩等蓋住感應燈帶，然後抓在遮蓋物上推嬰兒手推車。
- 拉嬰兒手推車時，僅接觸把手內側，而未觸碰到感應燈帶。
- 僅抓握按鈕所在的把手中央部位來移動嬰兒手推車。

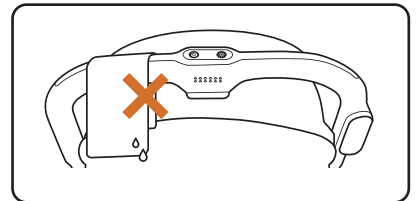

警告：當使用自動剎車功能時，如果誤採用如下使用方法，可能會因剎車無法正確啟動而導致意外事故。

- 請勿用車罩等遮蓋住自動剎車、前燈鍵與把手感應燈帶。
- 請勿在把手上懸掛金屬片。
- 請勿在把手上懸掛濕毛巾。
- 請勿在把手上置掛智能手套等導電性高的物品。

WARNING : the Intelligent Auto-Brake is an assistant device, and its functions (identification and control capability) have their limitation. Do not place too much reliance on such capabilities.

Pay regular attention to the surrounding conditions and use it in a safe way. Intelligent Auto-Brake system may underperform or fail to function soundly due to undesirable road conditions, weather conditions, stroller status, etc.

警告：自動剎車為輔助裝置，各項功能的能力（識別能力、控制能力）有其極限。

請不要過度信任各項功能的能力，應經常注意周邊狀況，安全使用。

自動剎車輔助裝置會因道路狀況、天氣狀況、車輛狀態等原因，出現無法啟動或是無法充分發揮性能的情況。

Integral touch panel 智能安全輔助系統

Tip for the handle

When using the intelligent Auto-Brake, hold the touch panel of the handle by hand to unlock the brake.

手把溫馨提示

使用自動剎車時，手握住把手感應燈帶區域，剎車解鎖。

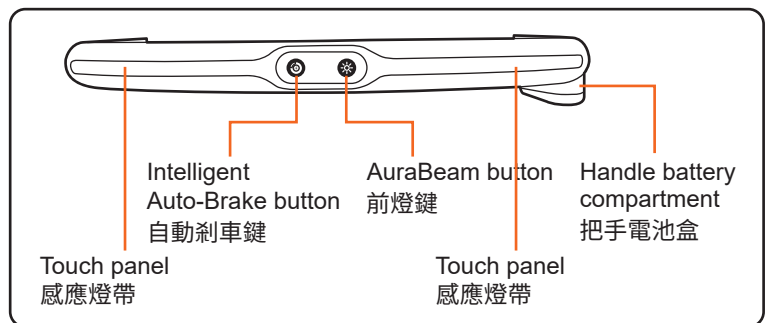

Enabling the Intelligent Auto-Brake 啟動自動剎車鍵

- To enable this mode, press and hold the Intelligent Auto-Brake button for 2 seconds. A startup prompt tone will be heard.
- The Intelligent Auto-Brake button will always on.
- The touch panel will blinks three times with an interval of 1 second, and then it goes off.

Tip: when the Intelligent Auto-Brake button is lit in blue, it means that the Intelligent Auto-Brake assistant device is activated.

- 將智能模式上的開關打開，長按自動剎車按鍵2秒開啟，同時開機提示聲播放。
- 自動剎車啟動鍵LED燈常亮。
- 把手LED燈帶全亮閃爍三次，閃爍間隔1秒，然後燈帶關閉。

提示：當自動剎車按鈕呈藍色點亮時，表示自動剎車輔助裝置處於啟動狀態。

To be continued
轉下頁

Disabling the Intelligent Auto-Brake 關閉自動剎車鍵

- Press and hold the Intelligent Auto-Brake button for 2 seconds. A shutdown prompt tone will be heard.
- The touch panel will blink three times with an interval of 1 second, and then it goes off.
- The intelligent Auto-Brake button will go off.

Tip: when the Intelligent Auto-Brake button is not lit in blue, it means that the Intelligent Auto-Brake assistant device is not activated.

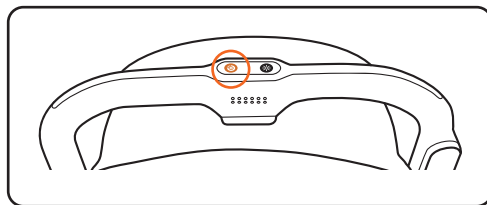

WARNING : The minimum distance from the luminaire to any lighted objects shall be kept at least 0.3m. Never operate the handle buttons at will. If any button does not function well due to failure to following the instructions, please contact the after-sales service.

- 自動剎車開啟情況下，2秒可以關閉，同時關機提示聲播放。
- 把手LED燈帶全亮閃爍三次，閃爍間隔1秒，然後燈帶關閉。
- 自動剎車啟動鍵LED燈關閉。

小提示：當自動剎車按鈕未呈藍色點亮時，表示自動剎車輔助裝置處於未啟動狀態。

警告：燈具到任何被照亮物體之間至少應保持 0.3 米的距離。不可隨意操作把手按鍵。如果按鍵操作不按說明書進行，造成功能失常，請聯繫售後服務。

To power on/off the AuraBeam 開啟/關閉前燈

- Press and hold the AuraBeam button for 2 seconds. Check if the AuraBeam and AuraBeam button turn on.
- Press and hold the AuraBeam button for 2 seconds. Check if the AuraBeam and AuraBeam button turn off.
- 長按前燈鍵2秒，確認前燈和前燈鍵是否開啟。
- 長按前燈鍵2秒，確認前燈和前燈鍵是否關閉。

To change the mode of AuraBeam 改變前燈模式

- After AuraBeam is turned on, press the AuraBeam button to change mode.
- It can be changed to a) Constant mode, b) Breathing mode.
- 前燈開啟情況下，按下前燈鍵可以更換模式。
- 可更換的模式有：a.是常亮模式。b.呼吸式明暗轉換。

Operation of Intelligent Auto-Brake 推車自動剎車解剎與剎車狀態

- To release the Intelligent Auto-Brake, hold the touch panel until it lights up. It can be moved around. The panel light will go off after touching for 3 seconds.
- To activate the intelligent auto-brake, hands off from the handle.
- The stroller will be auto-braked after running a certain distance (approx.. 50cm), if you are on the ground (i.e. less than 3 degree). Otherwise, it will be auto-braked immediately.

CAUTION : Do not over-trust the function of electric brake when parking.

Note : Do not suggest using the Intelligent Auto-Brake with gloves (Greater than 4mm). Wearing gloves will affect the stability of intelligent Auto-Brake.

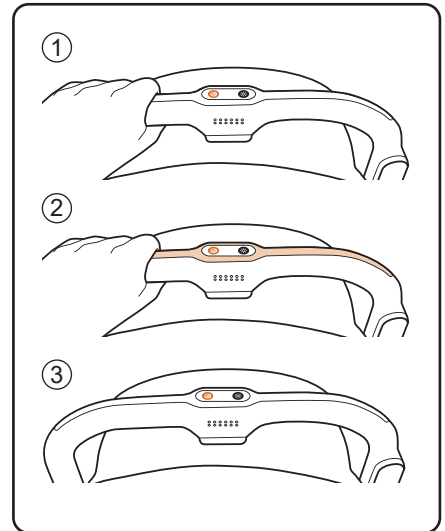

- 手握推車把手，去解鎖自動剎車，可正常推行，觸碰手把3秒後燈會熄滅。
- 手離開把手，會啟動自動剎車。
- 如在平地 (小於3度)推車會在一定距離後剎車 (大約50CM)，否則會在手離開手把後馬上剎車。

注意: 停車時請勿過分信賴電動剎車功能。

小提示: 不建議帶手套(大於4mm) 使用自動剎車, 帶手套使用自動剎車可能會造成剎車功能不穩定。

Low battery capacity tip 電池低電量提醒

Battery capacity 電池電量	Tip 提示	Unlocking operation 解鎖操作
<ul style="list-style-type: none"> • The Main battery / handle battery is less than 20% of its full capacity. • 主控模塊 / 手把電池低於20%。 	<ul style="list-style-type: none"> • If the Intelligent Auto-Brake button / AuraBeam button blinks for nine times, it means the Main battery / handle battery is less than 20% of its full capacity. • 如果自動剎車鍵/前燈鍵閃爍了九次,這代表主控模塊/手把電池電量少於20%。 	<ul style="list-style-type: none"> • Hands on the handle to unlock it. • 手握把手解鎖。
<ul style="list-style-type: none"> • The Main battery / handle battery is less than 10% of its full capacity. • 主控模塊 / 手把電池低於10%。 	<ul style="list-style-type: none"> • If the capacity goes below 10%, the Intelligent Auto-Brake button / AuraBeam button blinks for nine times while the stroller will be locked even your hands on the handle. • 如果電量少於10%,自動剎車鍵/前燈鍵會閃爍了九次同時當手離開手把時,手推車會被鎖即使手在手把上。 	<ul style="list-style-type: none"> • If the Main battery / handle battery is lower than 10% of its full capacity, the Intelligent Auto-Brake need to turn off for unlocking the stroller. The dry cell must be charged or replaced. • 如果主控模塊 / 手把電池低過10%,如要解鎖必先要把自動剎車關上,電池必需充電或更換。

Note : Intelligent Auto-Brake Button blinks mean the Main battery is low in capacity.

Note : AuraBeam Button blinks mean the handle battery is low in capacity.

小提示:自動剎車鍵閃爍時代表主控模塊電量低。

小提示:前燈鍵閃爍時代表手把電池電量低。

Change of dry cell 乾電池更換

- ① Remove the screw with a cross screwdriver.
 - ② Pay attention to the polarity in replacing the dry cell.
 - ③ After changing the dry cell, put the battery cover back.
- ① 使用十字螺絲刀起子將螺絲拆卸下來。
 - ② 更換乾電池注意分清電池的正負極。
 - ③ 更換完成後將電池蓋板安裝好。

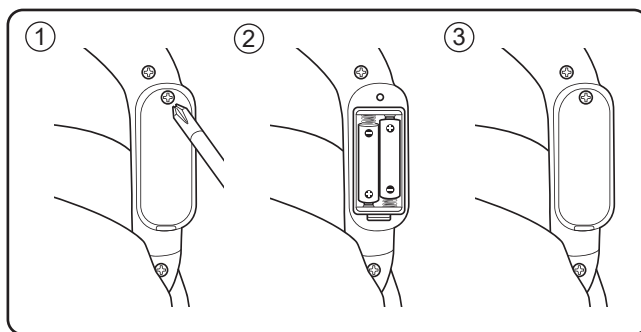

CAUTION:

Instructions for batteries in the handle:

- ① Use 2 x 1.5V AAA batteries.
- ② Do not use rechargeable batteries or zinc-manganese batteries.
- ③ Batteries of different types or new and old batteries cannot be used together.
- ④ Exhausted batteries should be removed from the handle.
- ⑤ No short circuit is allowed at the power terminal.

注意:

手把中的電池使用說明:

- ① 使用2顆 1.5VAAA電池。
- ② 不得使用充電電池或鋅錳電池。
- ③ 不同類型的電池或新舊電池不能混用。
- ④ 用盡的電池應從手中取出。
- ⑤ 電源端不得短路。

To be continued

轉下頁

Main battery power switch 主控模塊電源開關

Please turn on the switch before installing the Main battery.

Note : please charge the Main battery before use.

主控模塊安裝前請將電源開關打開。

注意：使用前請給主控模塊充電。

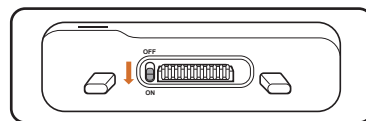

Main battery installation 主控模塊安裝

- ① Pay attention to the two white plug-in holes when installing the Main battery. Let the plug-in gap face right, and pay attention not to reverse the direction.
 - ② After aligning to the holes, press the module inward until a click is heard. It indicates a successful installation.
- ① 安裝主控模塊時注意兩個白色的插件孔位。將插件缺口對著右邊，注意方向不要反了。
- ② 孔位對準後按壓進去，聽見咔嚓聲安裝完成。

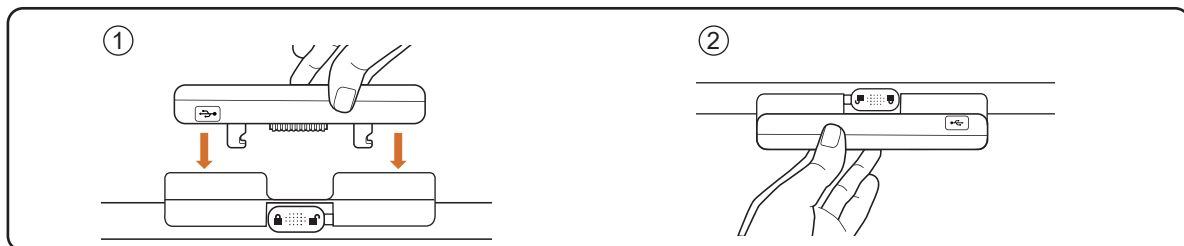

Main battery removal 主控模塊拆卸

Pay attention to slide the button in the red box to the right to unlock it, and then you can remove the Main battery.

注意將紅色框內的按鍵向右滑動解鎖，即可將主控模塊拆卸。

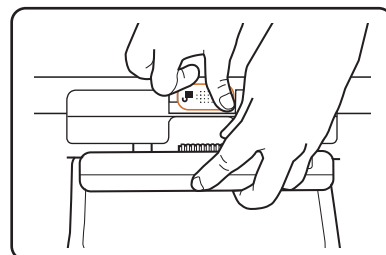

Main battery charging indication 主控模塊充電提示

- The charging state will display if the Micro-USB charging cable is inserted.
Charging indication :
 - a. Displays run from one LED light to five LED lights, and then repeats.
 - b. The blinking will stop when the Main battery is fully charged. Five LED lights are on.
- 將充電線插入即可顯示充電狀態。
充電提示：
 - a. 從第一格開始顯示到第五格，然後再從頭顯示。
 - b. 電量充滿後將不會在循環閃爍，指示燈全亮。

CAUTION :

- When charging the Main battery, never bend, pull or twist the Micro-USB charging cable, or place any heavy object on the cable.
- When charging the Main battery, keep it in a safe place away from children.
- Clean the Micro-USB charging connector and the battery regularly.
- Do not touch the Micro-USB charging connector and the battery with a wet hand.
- When charging the Main battery, use the attached Micro-USB charging cable.
- The attached Micro-USB charging cable is dedicated to this product. Do not use it for other purposes than charging this product.
Other chargers with a connector of the same shape may cause problems due to different pin design. Similarly, do not use other charging cables to charge the product.
- Always unplug the charging cable when the charging completes.
- Protect the Micro-USB charging cable from being damaged.
- Battery is a consumable that may deteriorate even in normal use. Battery wear is a normal feature, not a fault.
- In an environment of low temperature, Main battery life will be shortened.
- The rechargeable battery cannot be removed or replaced.
- Please make sure that the Main battery is charged by an adult.

注意：

- 充電時，請勿用力彎曲、拉拽、扭曲 USB 充電線，也不要將重物壓線上。
- 充電時，請勿讓兒童在旁邊玩耍。
- 請定期清掃 USB 充電連接器部分以及主控模塊。
- 請勿用濕手觸摸 USB 充電連接器部分以及主控模塊。
- 充電時，請使用附帶的 USB 充電線。
- 附帶的 USB 充電線為本產品專用。請勿用於本產品充電以外的用途。
即使連接器的形狀相同，也有可能因為針腳設計不同而導致故障。
同樣，請勿使用其他產品所附帶的充電線對本產品進行充電。
- 充電結束後，請務必拔下充電線。
- 請勿讓 USB 充電線受損。
- 電池屬於消耗品，即使是正常使用也會出現劣化。電池損耗是其正常特性，並非故障。
- 在環境溫度較低的環境中，主控模塊續航時間會縮短。
- 充電電池設計為不可拆卸更換。
- 主控模塊由成人充電。

To be continued
轉下頁

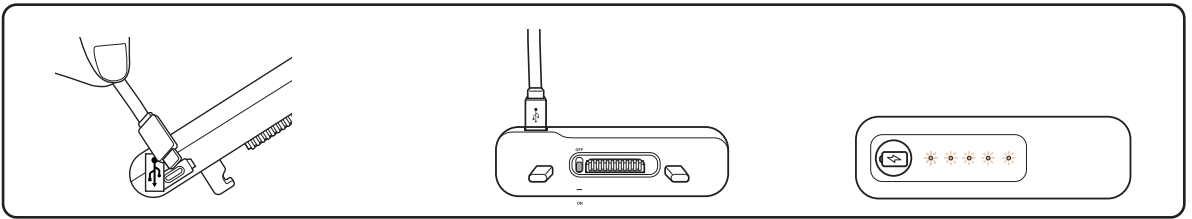

WARNING :

The Main battery cannot be exposed to the sun or charged under the sun. If you want to remove the Main battery or the dry cell, disable the automatic braking function first. (Otherwise, the stroller cannot be used because the main body is not locked)

警告:主控模塊不能太陽下暴晒,或者在太陽暴晒下充電。

如需取下主控模塊或乾電池,請在自動剎車功能關閉狀態下進行(否則會發生車體未解鎖不能使用)。

Main battery indicator 主控模塊電量顯示

- Press the button on the Main battery to view the Main battery capacity.
- See the right figure for the Main battery capacity and LED light indicators.

NOTE:

- Sleeping state, the Main battery used 330 days, the average daily use of the car body 2hours, the Main battery can use 19 days.
- In the dormant state, the handheld battery lasts 130 days. The average daily use of the car body is 2hours. The handheld battery lasts 40 days.
- Charging time of Main battery Time=3~4hours

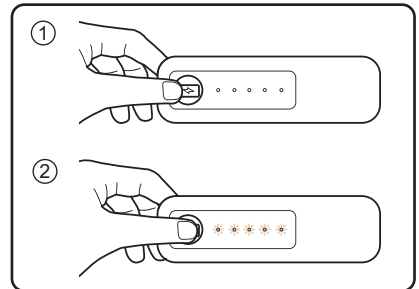

WARNING : AC power supply and DC power supply with voltage greater than 5V are prohibited. The Main battery in the stroller cannot be replaced without permission (if so, please contact The after-sales department.) and make sure it is not charging while using the stroller.

- 按壓主控模塊上面的按鍵,即可查看鋰電池當前的電量顯示。
- 當前的主控模塊電量與顯示LED燈的參數見右圖表。

小提示

休眠狀態,主控模塊使用時間330天,車體平均每天使用2小時,主控模塊可使用19天
 休眠狀態,手把電池使用時間130天,車體平均每天使用2小時,把手電池可使用40天
 主控模塊充電時間 T=3~4小時

警告:禁止使用AC電源及電壓大於5V的DC電源。推車中的主控模塊不可私自更換(如需更換,請聯系售后),請勿在推車中直接充電。

Awakening function 喚醒功能

In the sleep mode, the stroller can be awakened and resume to normal status by touching the handle.

推車在睡眠模式下，通過手觸摸把手可以喚醒，喚醒後恢復正常使用。

Matching and canceling Main battery with the handle 主控模塊與把手的配對和解除

Matching the Main battery with the handle

1. Pull out the Main battery.
2. Press the switch button on the battery until all the indicators flash.
3. Put it within 20cm near the touch panel.
4. Press the Intelligent Auto-Brake button for 5 times.
5. The touch panel lights up to indicate a successful matching.

主控模塊與把手配對

1. 拔出主電池。
2. 按下電池上的電源鍵，直到所有的指示燈閃爍。
3. 把它放在距離把手20釐米以內的地方。
4. 按電源鍵5次。
5. 感應燈帶亮起表示配對成功。

Canceling the match between the Main battery and the touch panel

1. While pressing the AuraBeam button, press the Intelligent Auto-Brake button for 5 times.
2. Blinking light for Intelligent Auto-Brake means a successful unpairing.

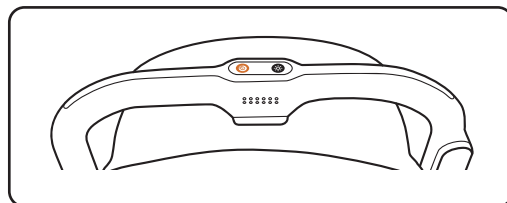

主控模塊與把手解除配對

1. 按住前燈鍵，連續按自動剎車鍵5次。
2. 自動剎車鍵的燈閃爍意味着成功的解除配對。

Horizontal calibration 主控模塊的水平校準

While pressing the AuraBeam button, press the Intelligent Auto-Brake button for 8 times.

按住前燈鍵，連續按自動剎車鍵8次。

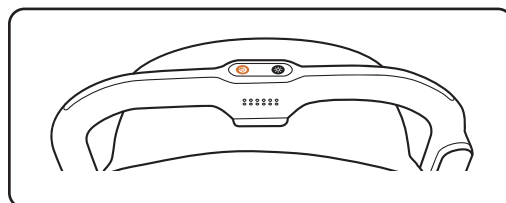

WARNING : If the external flexible cable or cord of this luminaire is damaged, it shall be exclusively replaced by the manufacturer or this service agent or a similar qualified person in order to avoid a hazard.

警告 : 如果此燈具的外部柔性電纜或電線損壞，應由製造商、服務代理商或類似合格人員專門進行更換，以免危險。

Preparation before use 使用前的準備

1. Switch the power switch of the Main battery to "ON".
2. Confirm that at least two battery level indicators are lit on.
3. Confirm that the Main battery is securely attached and fixed to the stroller.
4. Confirm that the front and rear wheels are securely attached and fixed to the stroller.
5. Install AAA batteries in the battery compartment of the handle correctly. Do not use rechargeable batteries or use new and used batteries together.
6. The metal parts of the handle battery compartment shall be kept from being oxidized.
7. Keep the handle dry.
8. Do not hang any metal parts on the handle.
9. Press and hold the start button of the Intelligent Auto-Brake to check whether it is activated.
10. Grasp the handle and push the stroller back and forth to make sure that the automatic brake does not work.
11. Release the handle, and make sure that the Intelligent Auto-Brake will work after moving the stroller forward for a short distance.

When the above preparation is completed, activate the Intelligent Auto-Brake function. When there are other problems, please deal with them with the following methods. If the problem persists after the treatment is performed, stop using the product and contact the after-sales service center as shown below.

1. 將主控模塊的電源開關設為“ON”。
2. 確認主控模塊的剩餘電量指示燈有兩個以上燈點亮。
3. 確認主控模塊已正確安裝到車身上並固定好。
4. 確認前輪與後輪已正確安裝到車身上並固定好。
5. 應將 AAA 電池正確安裝到把手的電池倉中，不要使用充電電池，也不要新舊電池混用。
6. 把手電池倉的金屬部件不得出現氧化。
7. 把手應保持乾燥。
8. 不得將金屬部件掛在把手上。
9. 長按嬰兒手推車自動剎車的啟動按鈕，確認其是否啟動。
10. 抓握住把手，前後推動嬰兒手推車，確認自動剎車不生效。
11. 鬆開把手，確認稍稍前進一段距離後自動剎車生效。

上述準備作業完成後，請啟動自動剎車。當存在其他問題時，請依據以下處理方法予以處理。當處理之後問題依然未能解決時，請暫停使用產品，與如下所示的售後服務中心洽詢。

To be continued
轉下頁

Trouble shooting 疑是產品故障時

	When such conditions happens 當出現這種狀況時	Possible cause 推測原因	Check and treatment 確認及處理
1	The Main battery level indicator is not lit. 主控模塊的剩餘電量指示燈不亮。	The Main battery switch is not turned on 主控模塊開關未開啟	① Check whether the Main battery switch is turned to "ON". If not, set it to "ON". ① 檢查主控模塊開關是否處於“ON”狀態，並將其設為“ON”。
		The Main battery is not charged 主控模塊未充電	② Confirm that there is no foreign matter attached to the USB charging cable connector and the charging cable is not deformed. After charging the Main battery, set the Main battery switch to "ON". ② 確認 USB 充電線的連接器上無異物附著、充電線無變形，給主控模塊充電後，將主控模塊開關撥至“ON”。
2	The Intelligent Auto-Brake is not started and the AuraBeam is not lit even if the Intelligent Auto-Brake or the AuraBeam button is pressed. 即使按下自動剎車或前燈鍵，也不啟動、不亮燈。	The Main battery switch is not turned on 主控模塊開關未開啟	① Check whether the Main battery switch is turned to "ON". If not, set it to "ON". ① 檢查主控模塊開關是否處於“ON”狀態，並將其設為“ON”。
		The Main battery capacity is exhausted 主控模塊電量用盡	② Charge the Main battery. ② 給主控模塊充電。
		The Main battery is not correctly installed 主控模塊未正確連接	③ Check the connection between the Main battery and the stroller, and make sure that the Main battery is loaded correctly. ③ 確認主控模塊與嬰兒手推車之間的連接狀態，並正確安裝。
		No dry cell is loaded 未安裝乾電池	④ Load the dry cell into the battery compartment of the handle. ④ 將乾電池裝入把手的電池倉中。
		The dry cell battery capacity is exhausted 乾電池的電量用盡	⑤ Replace the dry cell in the battery compartment of the handle. ⑤ 更換把手主控模塊倉中的乾電池。
3	The Intelligent Auto-Brake button blinks in blue. 自動剎車按鈕呈藍色閃爍。	The Main battery and the handle are not paired 主控模塊與把手未配對	The Main battery and the handle must be paired. Please follow the instructions in "Pairing and unpairing the Main battery with the handle" on page 30 of this manual. 主控模塊與把手必須配對，所以請按照本書第 30 頁中記載的“主控模塊與把手配對及解除配對”進行操作。
4	The Intelligent Auto-Brake button blinks in blue for 30 seconds and then lights in red. 自動剎車按鈕呈藍色閃爍 30 秒後，呈紅色點亮。	Any foreign substance adheres to the contact part of the Main battery 主控模塊的接觸部分附著有異物	Make sure that no foreign substance adheres to the contact part of the Main battery. If there is any, remove it completely. 確認主控模塊的接觸部分沒有異物附著，如果有異物附著，應將異物清掃乾淨。
5	The AuraBeam button blinks in blue constantly. 前燈鍵一直呈藍色閃爍。	Any foreign substance adheres to the contact part of the Main battery 主控模塊的接觸部分附著有異物	Make sure that no foreign substance adheres to the contact part of the Main battery. If there is any, remove it completely. 確認主控模塊的接觸部分沒有異物附著。如果有異物附著，應將異物清掃乾淨。

To be continued

轉下頁

	When such conditions happens 當出現這種狀況時	Possible cause 推測原因	Check and treatment 確認及處理
6	Place the stroller body on a flat ground (in static state) and release the handle from your hand, and then the Intelligent Auto-Brake will be locked automatically. 將車身放在平地上(靜止狀態下),手鬆開把手,自動剎車被自動鎖定。	Stroller body level correction has not been performed properly 未正確進行車身水準校正	Please read the level correction method in this manual carefully for correct operation. 請仔細閱讀本書的水準校正方法,正確進行操作。
7	When the Intelligent Auto-Brake and the AuraBeam are set to "ON" or "OFF", the indicator light and the functions of the buttons are normal, but no sound is heard. 將自動剎車與前燈設為“ON”或“OFF”時,按鈕的指示燈與功能正常,不發出聲音。	The dry cell capacity is extremely low 乾電池的電量過低	Replace the dry cell in the handle battery compartment. 更換把手電池倉中的乾電池。
8	When the AuraBeam is switched to lighting or blinking mode, no sound is heard. 切換前燈的亮燈或閃爍模式時,不發出聲音。	Program error 程序異常	Switch the Auto-Brake button temporarily to "OFF" and then reset it to "ON". 應將前燈鍵暫時設置為“OFF”,然後再重新設為“ON”。
9	The sensing area of the handle is normal and a sound can be heard during braking, but the rear wheel brake can be unlocked on only one side or neither side. 把手的感應部分正常,剎車時也會有提示音,但後輪的剎車僅單側能鎖定,或是兩側均無法鎖定。	Incorrect rear wheel installation 後輪安裝不正確	Remove the rear wheel and check whether there is any foreign matter adhered to. If any, please remove it. 拆下後輪,確認是否有異物附著。當有異物附著時,請清掃乾淨。
10	The sensing area of the handle is normal, but the rear wheel brake can be unlocked on only one side or neither side. 把手的感應部分正常,但後輪的剎車僅單側能解除鎖定,或是兩側均無法解除鎖定。	Incorrect rear wheel installation 後輪安裝不正確	① Remove the rear wheel and check whether there is any foreign substance adhered to. If any, please remove it. ① 拆下後輪,確認是否有異物附著。當有異物附著時,請清掃乾淨。
		Program error 程序異常	② Remove the batteries and install them back, and hold the handle for 3 seconds. ② 請暫時將電池拆下然後重新安裝好,握住把手 3 秒。
11	The AuraBeam button displays correctly, and when it is switched to blinking or lighting mode, a sound can be heard as normal, but the AuraBeam does not light. 前燈鍵正確顯示,切換為閃爍或亮燈模式時也會正常發出提示聲音,但是前燈不亮燈。	Any foreign substance adheres to the contact part of the Main battery 主控模塊的接觸部分附著有異物	Make sure that no foreign substance adheres to the contact part of the Main battery. If any, remove it. 確認主控模塊的接觸部分沒有異物附著。如果有,請將其清掃乾淨。
12	The Intelligent Auto-Brake button lights in blue, handle touch panel does not lit. 自動剎車鍵藍燈亮起,把手感應燈帶不亮燈。	Program error 程序異常	Take out the dry cell and reinstall it. 將乾電池取出後重新安裝。

Maintenance and Cleaning 保養和清潔

- Never apply force on any mechanism or moving parts.
 - To prevent mildew forming, do not store this product in a wet or humid environment.
 - Avoid prolonged exposure of the product to rain or snow.
 - Clean the plastic and metal parts with a wet cloth. For stubborn stains, use a diluted mild detergent.
 - You may lubricate moving parts if the operation or movement of the stroller is not smooth. Do not apply excessive lubricant as it may stain with dust which may cause malfunction.
 - Please do not apply any lubricating oil on open/fold lock, safety belt buckle, front guard plug, safety lock, folding lever and swiveling lock that will cause malfunction.
-
- 切勿強行拉動活動零件或裝置。
 - 請勿將產品存放在潮濕的地方以免產品發霉。
 - 避免將產品長時間暴露於雨水或雪霜之中。
 - 請以濕布清潔金屬及塑膠部分。如遇頑固污垢，可使用稀釋的清潔劑。
 - 若感到手推車操作或運行不順暢時，可以添加適量的潤滑劑。注意不要添加過多的潤滑劑，否則反而會容易沾上灰塵，引起操作異常。
 - 注意某些部位不可以加潤滑劑，如把手操作部、座席安全帶扣、前護欄的安裝部、開閉鎖周圍、轉向輪回轉部，否則可能引起運作不良。

Cleaning and maintaining fabrics 清洗和保養縫製品

- Be careful not to damage the plastic part of canopy and the basket.
 - Due to the characteristic of the product, the color may fade after washing for several times.
 - It is recommended to wash with neutral detergent. Do not use detergent containing fluorescent brightener or bleach. This may cause chapped skin or a rash.
 - Always keep clean due to the condition of storage, the mildew may be generated.
-
- 請注意不要損壞車篷的塑膠部分或菜籃等。
 - 根據產品的特性，多次清洗后可能會有輕微的褪色。
 - 洗滌的時候建議使用中性洗滌劑。請勿使用含螢光劑、漂白劑的洗滌劑，因為可能會引起皮膚乾燥、濕疹等。
 - 請小心洗滌及保持清潔，同時需確保縫製品保管於通風環境，避免發霉狀況。

Washing of the seat cushion, front guard cover, shoulder belt, waist belt 座墊、前護欄套、肩帶、腰帶的洗滌方法

- Hand wash in warm water or machine-wash gently .
- When using the washing machine, put the laundries into the washing net before washing. Otherwise a fray and damage may cause.
- After washing, please twist it gently to make it dry. Hard twist may leave folds onto the fabric.
- Some sewing parts can discolor, so it is recommended to wash and spin separately with other clothes. Do not soak into the water.
- Rinse thoroughly, wring out lightly, and then arrange the shape and dry in the shade.
- Do not use drying machine, iron and dry cleaning.
- 請以溫水手洗或弱速機洗。
- 使用洗衣機的時候，請將縫製品放入柔洗袋內，避免縫製品損壞。
- 洗滌後，請輕輕地擰乾，大力擰乾的話可能會使縫製品留下褶皺。
- 部分縫製品可能會出現掉色，請跟其他物品分開清洗，另外請避免浸泡。
- 徹底清洗後，輕輕擰乾後，整理好形狀，放於陰涼處晾乾。
- 請勿使用烘乾機、熨斗及乾洗。

Washing of the seatback, canopy, basket, crotch belt 座席、車篷、置物籃、中央帶的清洗方法

- Do not soak into the water. Use sponge or brush wipe off the dirt with warm water.
- After wipe off the dirt by detergent, use a cloth to wipe off the excess water and detergent.
- Dry in shade area after wipe off water.
- 請勿將縫製品浸泡在液體中。請用海綿或毛刷並使用溫水來擦拭污垢。
- 當使用清潔劑擦拭後，請以幹布或海綿將多餘的水分或清潔劑抹淨。
- 擦拭後請置於陰涼處陰乾。

The frequency and power of band radio wave / 無線電頻率和功率：

2402MHz – 2480MHz @ 6.380 dBm (4.34mW)

Consumers from Hong Kong and South East Asia countries please refer to below / 香港和東南亞地區消費者請參考下面：

Manufacturer / 生產商: Combi Holdings Limited / 康貝控股有限公司

Supplier / 供應商:

Combi Hong Kong Limited

Room 1003, HK Pacific Centre, 28 Hankow Road,

Tsim Sha Tsui, Kowloon, Hong Kong.

香港九龍尖沙咀漢口道28號亞太中心1003室康貝香港有限公司

台灣地區消費者請參考下面：

- | | | |
|-----------|---|------------------------|
| 產品名稱及型號 | : | 手推嬰幼兒車 AuraStar |
| 製造年份 | : | 請參考車體腳管貼紙 |
| 進口商 | : | 台灣康貝股份有限公司 |
| 地址 | : | 台北市11493內湖路一段360巷6號6樓 |
| 電話 | : | (02)7720-8585 |
| 統一編號 | : | 12946262 |
| 製造廠商 | : | 康貝控股有限公司 |
| 地址 | : | 香港九龍尖沙咀漢口道28號亞太中心1003室 |
| 原始製造國 | : | 中國 |
| 適用年齡 | : | 一至三十六個月 |
| 最大體重 | : | 15kg以下 |
| 置物籃最大承載重量 | : | 5kg以下 |
| 主要成份或材質 | : | 鋁合金、聚酯纖維布、尼龍塑膠 |
| 使用方法 | : | 請依說明書組合使用 |
| 注意事項 | : | 乘坐時務必繫好安全帶。 |
| 緊急處理方法 | : | 盡速送醫急救。 |

Combi Corporation

177396070